

Part No.	Description	Load Rate
83AMWO	8" x 3" AXLE MOUNT WHEEL (PLAIN) NO BEARINGS Offset: Negative 10	375kg
83HTWO	8" x 3" HT MAG WHEEL (PLAIN) c/w MAG WHEEL NUTS P.C.D: 5/108 Offset: Negative 10	375kg
945AMWO	9" x 4.5" AXLE MOUNT WHEEL (PLAIN) c/w BEARINGS Offset: 0	610kg
945HTWO	9" x 4.5" HT MAG WHEEL (PLAIN) c/w MAG WHEEL NUTS P.C.D: 5/108 Offset: Negative 10	650kg
103AMWO	10" x 3" AXLE MOUNT WHEEL (PLAIN) c/w BEARINGS Offset: 0	550kg
1035HTMWO	10" X 3.5" HT MAG WHEEL (PLAIN) c/w MAG WHEEL NUTS P.C.D: 5/108 Offset: Negative 6	550kg
1035MMWO	10" X 3.5" MINI MAG WHEEL (PLAIN) c/w MAG WHEEL NUTS P.C.D:4/101.6 Offset: Negative 6	550kg



Part No.	Description	Weight
SA13FG	13 x 4.5 Galv Ford Wheel Inner/Outer: 70/70 Offset: Zero	750kg
SA14FG	14 x 6 Galv Ford Wheel Inner/Outer: 105/70 Offset: Positive 18	850kg
SA14FW	14 x 6 White Ford Wheel Inner/Outer: 102/75 Offset: Positive 14	850kg
SA14HTW	14 x 6 White HT Wheel Inner/Outer: 102/75 Offset: Positive 14	850kg
SA14HQW	14 x 6 White HQ Wheel Inner/Outer: 102/75 Offset: Positive 14	850kg
SA14LCW	14 x 6 White TLC(6) Wheel Inner/Outer: 102/75 Offset: Positive 14	850kg
SA15FW	15 x 6 White Ford Wheel Inner/Outer: 90/85 Offset: Zero	1150kg
SA156LCW	15 x 6 White TLC(6) Wheel Inner/Outer: 90/85 Offset: Zero	1150kg
SA15LCW	15 x 7 White TLC(6) Wheel Inner/Outer: 94/110 Offset: Negative 7	1150kg
SA166LCW	16 x 6 White TLC(6) Wheel Inner/Outer: 97/90 Offset: Zero	1700kg
SA167LCW	16 x 7 White TLC(6) Wheel Inner/Outer: 102/102 Offset: Zero	1180kg
SA167LC5	16 x 7 White TLC(5) Wheel Inner/Outer: 102/102 Offset: Zero	1180kg



Part No.	Description	Weight
SA13165	165/70R13LT Tyre Only Tread Pattern: LRP118 Depth of Tread: 8mm Weight of Tyre: 6.9kg Speed Rating: 110km/h	530kg
SA14185X	185/65R14 Tyre Only Tread Pattern: ENERGY X1 Depth of Tread: 8mm Weight of Tyre: 8.1kg Speed Rating: 110km/h	530kg
SA14185	185R14C Tyre Only Tread Pattern: LRP138 Depth of Tread: 8.7mm Weight of Tyre: 9.9kg Speed Rating: 110km/h	825kg
SA14195	195R14LT Tyre Only Tread Pattern: WR082 Depth of Tread: 9.2mm Weight of Tyre: 10.8kg Speed Rating: 105km/h	925kg
SA15195	195R15LT Tyre Only Tread Pattern: LRP138 Depth of Tread: 9.2mm Weight of Tyre: 11.49kg Speed Rating: 105km/h	950kg
SA15225	225/70R15C Tyre Only Tread Pattern:WR082 Depth of Tread: 8.8mm Weight of Tyre:13.41 kg Speed Rating: 110km/h	1120kg



LRP118



ENERGY X1



LRP138



WR082

Part No.	Description	Weight
SA15235	235/75R15LT Tyre Only Tread Pattern: WR097 Depth of Tread: 11mm Weight of Tyre: 15.27kg Speed Rating: 105km/h	900kg
SA1531105	31x10.5R15 Tyre Only Tread Pattern: HD818 Depth of Tread: 9mm Weight of Tyre: 17.13kg Speed Rating: 110km/h	1030kg
SA16235	235/70R16 Tyre Only Tread Pattern: HD617 Depth of Tread: 9mm Weight of Tyre: 13.3kg Speed Rating: 110km/h	950kg



WR097



HD818



HD617

Part No.	Description
50010TT	500 x 10 TYRE & TUBE BRAND: DEESTONE SIZE: 5.00 - 10 RATING: 8 PLY TYPE: LIGHT TRUCK HIGHWAY TYRE PATTERN: D100
565009-J2	600 x 9 TYRE & TUBE JR VALVE BRAND: KENDA SIZE: 6.9/6.00 - 9 RATING: 6 PLY TYPE: HIGHWAY TYRE PATTERN: K364
564840	400 x 8 TYRE & TUBE BRAND: KENDA SIZE: 4.80/4.00 - 8 RATING: 6 PLY TYPE: HIGHWAY TYRE PATTERN: K371
564836	400 x 8 KNOBBY TYRE & TUBE BRAND: KENDA SIZE: 4.00 - 8 RATING: 4 PLY TYPE: TURF TYRE PATTERN: K304
571610	350 x 4 TYRE & TUBE BRAND: KENDA SIZE: 4.10/3.50 - 4 RATING: 4 PLY TYPE: TURF TYRE PATTERN: K352



D100



K364



K371



K304



K352



INNER TUBE
(METAL VALVE)



INNER TUBE
(RUBBER VALVE)



TUBELESS VALVE

Part No.	Description
50010T	500 x 10 TUBE ONLY VALVE TYPE: RUBBER SIZE: 4.00/4.50 - 10
553956	600 x 9 TUBE ONLY VALVE TYPE: METAL SIZE: 6.00 - 9
564640	600 x 9 TUBE ONLY VALVE TYPE: RUBBER SIZE: 6.00 - 9
564631	400 x 8 TUBE ONLY VALVE TYPE: RUBBER SIZE: 4.80/4.00 - 8
564621	350 x 4 TUBE ONLY VALVE TYPE: RUBBER SIZE: 3.50/4.00 - 4
TU-TR413	TUBELESS VALVE SIZE: 14"

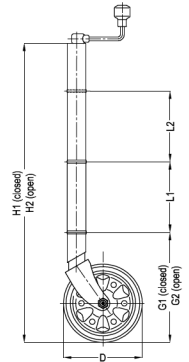

626100

6 x 2 JOCKEY WHEEL c/w CLAMP

WEIGHT (KG)	SURFACE FINISH	STATIC CAPACITY (KG)	OUTER TUBE DIAMETER	D (mm)	H 1 (mm)	H 2 (mm)	G 1 (mm)	G 2 (mm)	L 1 (mm)
5.5	ZINC PLATED	400KG	48mm	150	507	772	202	467	182



628100

8 x 2 JOCKEY WHEEL c/w CLAMP

WEIGHT (KG)	SURFACE FINISH	STATIC CAPACITY (KG)	OUTER TUBE DIAMETER	D (mm)	H 1 (mm)	H 2 (mm)	G 1 (mm)	G 2 (mm)	L 1 (mm)
7	ZINC PLATED	400KG	48mm	200	567	832	262	522	182



628325

8 x 2 EX. HEIGHT JOCKEY WHEEL c/w CLAMP

WEIGHT (KG)	SURFACE FINISH	STATIC CAPACITY (KG)	OUTER TUBE DIAMETER	D (mm)	H 1 (mm)	H 2 (mm)	G 1 (mm)	G 2 (mm)	L 1 (mm)
7	ZINC PLATED	400KG	48mm	200	730	995	370	635	132

Helpful Hint:

Use a large wheel for soft ground!



626204
6 x 2 JOCKEY WHEEL c/w SMALL
DOUBLE LOCKING PIN BRACKET

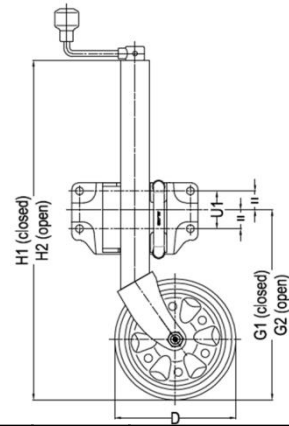

WEIGHT (KG)	SURFACE FINISH	STATIC CAPACITY (KG)	OUTER TUBE DIAMETER	D (mm)	H 1 (mm)	H 2 (mm)	G 1 (mm)	G 2 (mm)	U (mm) HOLE SIZE (ø14)
									U 1
									FOR DRAW BAR DEPTH
									50mm
7	ZINC PLATED	400KG	48mm	150	510	760	300	525	63



628204
8 x 2 JOCKEY WHEEL c/w
SMALL DOUBLE LOCKING PIN BRACKET

WEIGHT (KG)	SURFACE FINISH	STATIC CAPACITY (KG)	OUTER TUBE DIAMETER	D (mm)	H 1 (mm)	H 2 (mm)	G 1 (mm)	G 2 (mm)	U (mm) HOLE SIZE (ø14)
									U 1
									FOR DRAW BAR DEPTH
									50mm
8.5	ZINC PLATED	400KG	48mm	200	570	820	310	560	63

Helpful Hint:

Use a large wheel for soft ground!

622455

500KG FLIP UP JOCKEY WHEEL c/w BRACKET

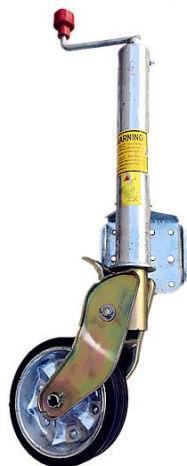

WEIGHT (KG)		SURFACE FINISH		STATIC CAPACITY (KG)		DYNAMIC CAPACITY (KG)		WHEEL DIM. & WIDTH (mm)	
10		ZINC PLATED		500KG		300KG		200 x 50	
DIM. A		DIM. B		DIM. C (MAX. TRAVEL) (mm)	DIM. D (OUTER TUBE DIAMETER)	DIM. E (mm)			
MIN. (mm)	MAX. (mm)	MIN. (mm)							
730	975	840	245	60mm	410				
DIM. F (mm)	DIM. G (mm)	DIM. H (mm)	DIM. K (mm)	DIM. L (mm)	DIM. M (MIN. mm)	DIM. N (mm)			
300	145	330	235	90	75	140			

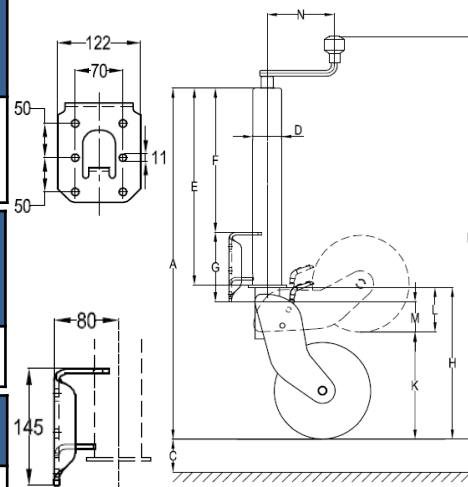

622800

800KG FLIP UP JOCKEY WHEEL c/w BRACKET



WEIGHT (KG)	SURFACE FINISH	STATIC CAPACITY (KG)	WHEEL DIM. & WIDTH (mm)	DIM. A (mm)	
				MIN.	MAX.
17	HOT DIP GALV	800KG	260 x 65	920	1140
DIM. B TUBE Ø	DIM. C (MAX. TRAVEL) (mm)	DIM. D (mm)	DIM. E (mm)	DIM. F (mm)	
73.5mm	225	450	355	190	

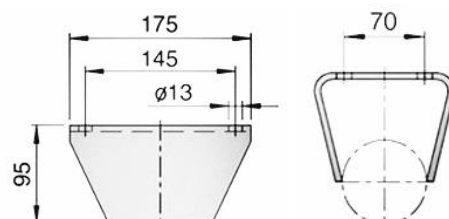
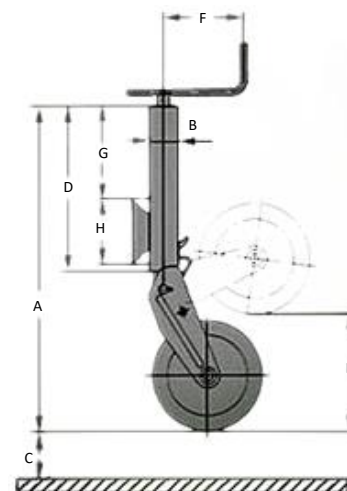



628200XP3
8 x 2 SOLID TYRE JOCKEY
WHEEL c/w 3 BOLT DOUBLE
LOCKING PIN SWIVEL BRACKET

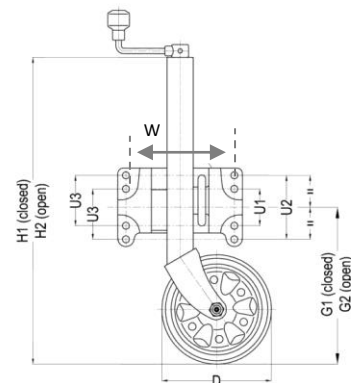

WEIGHT (KG)	SURFACE FINISH	STATIC CAPACITY (KG)	OUTER TUBE DIAMETER	D (mm)	H 1 (mm)	H 2 (mm)	G 1 (mm)	G 2 (mm)	W (mm)	U (mm) HOLE SIZE (ø14)		
										U 1	U 2	U 3
										FOR DRAW BAR DEPTH		
										50 mm	100 mm	75 mm
8.5	ZINC PLATED	400KG	48mm	200	570	820	305	522	185	63	113	88



623660XP3
250 x 80 SOLID TYRE JOCKEY
WHEEL c/w 3 BOLT DOUBLE
LOCKING PIN SWIVEL BRACKET

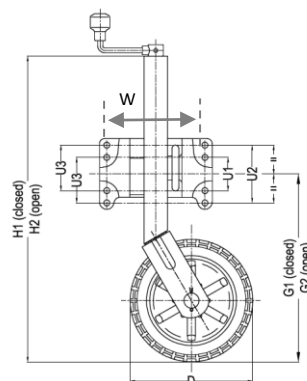

WEIGHT (KG)	SURFACE FINISH	STATIC CAPACITY (KG)	OUTER TUBE DIAMETER	D (mm)	H 1 (mm)	H 2 (mm)	G 1 (mm)	G 2 (mm)	W (mm)	U (mm) HOLE SIZE (ø14)		
										U 1	U 2	U 3
										FOR DRAW BAR DEPTH		
										50 mm	100 mm	75 mm
11	ZINC PLATED	400KG	48mm	250	630	880	320	570	185	63	113	88



628500
8 x 2 PREMIUM SIDE WIND JOCKEY
WHEEL c/w EXTRA WIDE CLAMP

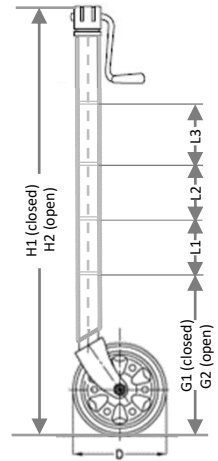

WEIGHT (KG)	SURFACE FINISH	STATIC CAPACITY (KG)	OUTER TUBE DIAMETER	D (mm)	H 1 (mm)	H 2 (mm)	G 1 (mm)	G 2 (mm)	L 1 (mm)	L 2 (mm)	L 3 (mm)
9.1	ZINC PLATED	400KG	48mm	200	771	1037	320	586	85	85	85



621250
250 x 80 SOLID TYRE POWER
MOVER JOCKEY WHEEL c/w CLAMP

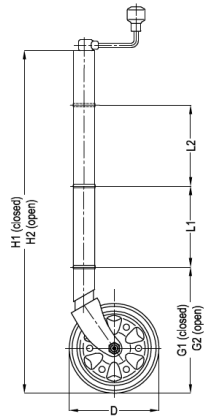

WEIGHT (KG)	SURFACE FINISH	STATIC CAPACITY (KG)	DYNAMIC CAPACITY (KG)	OUTER TUBE DIAMETER	D (mm)	H 1 (mm)	H 2 (mm)	G 1 (mm)	G 2 (mm)	L 1 (mm)	L 2 (mm)
14.7	ZINC PLATED	350KG	150KG	48mm	245	625	875	335	585	85	85

Helpful Hint: Use a large wheel for soft ground!



626050

T/T 6 x 2 LIGHT DUTY JOCKEY WHEEL c/w CLAMP

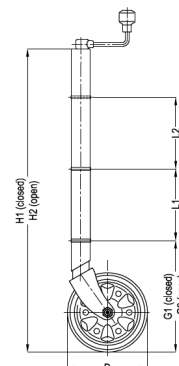

WEIGHT (KG)	SURFACE FINISH	STATIC CAPACITY (KG)	OUTER TUBE DIAMETER	D (mm)	H 1 (mm)	H 2 (mm)	G 1 (mm)	G 2 (mm)	L 1 (mm)
5	ZINC PLATED	350KG	48mm	150	510	760	202	457	180

629250TT

T/T 250 x 80 ZINC PLATED SOLID TYRE JOCKEY WHEEL c/w CLAMP



WEIGHT (KG)	SURFACE FINISH	STATIC CAPACITY (KG)	OUTER TUBE DIAMETER	D (mm)	H 1 (mm)	H 2 (mm)	G 1 (mm)	G 2 (mm)	L 1 (mm)
8	ZINC PLATED	350KG	48mm	245	635	885	325	575	180

Helpful Hint:

Use a large wheel for soft ground!

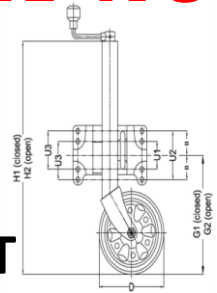

626190

**T/T 6 x 2 LIGHT DUTY JOCKEY WHEEL
c/w LARGE DOUBLE LOCKING PIN BRACKET**



WEIGHT (KG)	SURFACE FINISH	STATIC CAPACITY (KG)	OUTER TUBE DIAMETER	D (mm)	H 1 (mm)	H 2 (mm)	G 1 (mm)	G 2 (mm)	U (mm) HOLE SIZE (ø14)		
									U 1	U 2	U 3
									FOR DRAW BAR DEPTH		
									50 mm	100 mm	75 mm
6.75	ZINC PLATED	350KG	48mm	150	510	760	310	560	63	113	88

628200SLTT

**T/T 8 x 2 ZINC PLATED JOCKEY WHEEL
c/w LARGE DOUBLE LOCKING PIN BRACKET**



WEIGHT (KG)	SURFACE FINISH	STATIC CAPACITY (KG)	OUTER TUBE DIAMETER	D (mm)	H 1 (mm)	H 2 (mm)	G 1 (mm)	G 2 (mm)	U (mm) HOLE SIZE (ø14)		
									U 1	U 2	U 3
									FOR DRAW BAR DEPTH		
									50 mm	100 mm	75 mm
7.5	ZINC PLATED	350KG	48mm	200	570	820	310	560	63	113	88

629250SLTT

**T/T 250 x 80 ZINC PLATED JOCKEY WHEEL
c/w LARGE DOUBLE LOCKING PIN BRACKET**



WEIGHT (KG)	SURFACE FINISH	STATIC CAPACITY (KG)	OUTER TUBE DIAMETER	D (mm)	H 1 (mm)	H 2 (mm)	G 1 (mm)	G 2 (mm)	U (mm) HOLE SIZE (ø14)		
									U 1	U 2	U 3
									FOR DRAW BAR DEPTH		
									50 mm	100 mm	75 mm
10.5	ZINC PLATED	350KG	48mm	245	630	880	395	645	63	113	88

629900 JOCKEY WHEEL CLAMP



WEIGHT (KG)	SURFACE FINISH	OUTER TUBE DIAMETER	A (mm)	B ϕ (mm)
1	ZINC PLATED	48mm	150	13

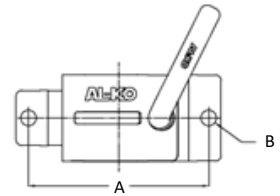

629920 LARGE DOUBLE LOCKING PIN BRACKET



WEIGHT (KG)	SURFACE FINISH	STATIC CAPACITY (KG)	OUTER TUBE DIAMETER	A (mm)	B (mm)	C (mm)	D (mm)
2.5	ZINC PLATED	400KG	48mm	185	88	63	113

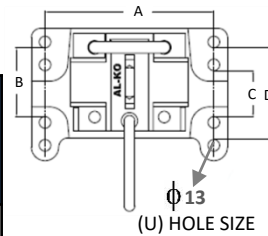

629923 SWIVEL BRACKET 3 BOLT LARGE



WEIGHT (KG)	SURFACE FINISH	STATIC CAPACITY (KG)	OUTER TUBE DIAMETER	A (mm)	B (mm)	C (mm)	D (mm)
2.65	ZINC PLATED	400KG	48mm	185	88	63	113

629935 DOUBLE LOCKING PIN BRACKET c/w CLAMP



WEIGHT (KG)	SURFACE FINISH	OUTER TUBE DIAMETER	A (mm)	B (mm)	C (mm)	D (mm)
3.3	ZINC PLATED	48mm	185	75	50	100



629600
6 x 2 SOLID
RUBBER WHEEL











629888
8 x 2 STEEL/
RUBBER WHEEL



629850
250 x 80 STEEL/
RUBBER WHEEL

Helpful Hint: Use a large wheel for soft ground!

PART NO.	DESCRIPTION	
626262	JOCKEY WHEEL U.BOLT KIT (75mm x 75mm)	
626260	JOCKEY WHEEL U.BOLT KIT (100mm x 75mm)	
629910	AK JOCKEY WHEEL MANOEUVRING HANDLE	
629915	AK JOCKEY WHEEL PREMIUM WIDE CLAMP (SPACING: 150mm x 50mm ; HOLE SIZE: 13mm)	
629602	STD. THRUST BEARING	
629601GS	JOCKEY WHEEL HANDLE c/w GRUB SCREW	
629601RP	JOCKEY WHEEL HANDLE c/w ROLL PIN	
629951	CLAMP HANDLE & BOLT	
629605	SCREWED SHAFT ONLY	



SABD-03A

STATIC CAPACITY (KG):
300

540mm
(CLOSED HEIGHT)

810mm
(OPEN HEIGHT)

170mm

6" JOCKEY WHEEL c/w CLAMP



SABD-03A2

STATIC CAPACITY (KG):
300

540mm
(CLOSED HEIGHT)

810mm
(OPEN HEIGHT)

170mm

6" JOCKEY WHEEL c/w LARGE DOUBLE LOCKING PIN BRACKET



SABD-03B

STATIC CAPACITY (KG):
300

570mm
(CLOSED HEIGHT)

835mm
(OPEN HEIGHT)

165mm

6 x 2" SIDE WIND JOCKEY WHEEL c/w DOUBLE LOCKING PIN BRACKET



SABD-03G1

STATIC CAPACITY (KG):
300

600mm
(CLOSED HEIGHT)

870mm
(OPEN HEIGHT)

230mm

8" JOCKEY WHEEL c/w LARGE DOUBLE LOCKING PIN BRACKET



**10" PNEUMATIC JOCKEY WHEEL
c/w CLAMP**



**10" PNEUMATIC JOCKEY WHEEL c/w
LARGE DOUBLE LOCKING PIN BRACKET**

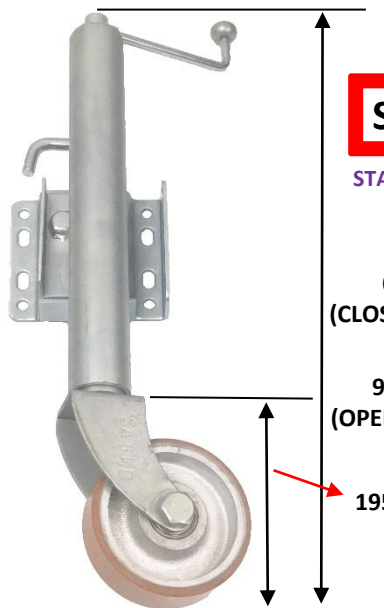

SA6HD-SA07

STATIC CAPACITY (KG):
600

670mm
(CLOSED HEIGHT)

970mm
(OPEN HEIGHT)

195mm

**6 x 2 HEAVY DUTY JOCKEY WHEEL
 c/w SINGLE LOCKING PIN BRACKET**

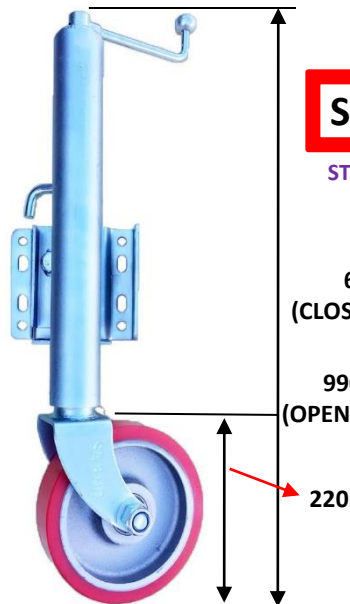

SA8HD-SA07

STATIC CAPACITY (KG):
1000

690mm
(CLOSED HEIGHT)

990mm
(OPEN HEIGHT)

220mm

**8 x 2 HEAVY DUTY JOCKEY WHEEL
 c/w SINGLE LOCKING PIN BRACKET**

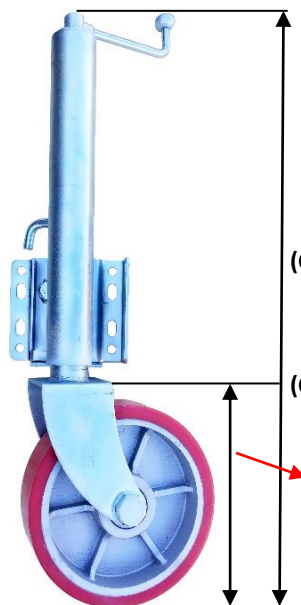

SA10HD-SA07

STATIC CAPACITY (KG):
1500

770mm
(CLOSED HEIGHT)

1030mm
(OPEN HEIGHT)

290mm

**10 x 2 HEAVY DUTY JOCKEY WHEEL
 c/w SINGLE LOCKING PIN BRACKET**

PART NO.	DESCRIPTION	
SASTB	SA SMALL THRUST BEARING	
SALTB	SA LARGE THRUST BEARING	
SA810SS/SN	SA H/D SCREWED SHAFT & NUT	
SABDWH	SA J/WHEEL HANDLE TO SUIT SABD J/WHEEL	
SA8WH	SA H/D J/WHEEL HANDLE TO SUIT SA8HD	
SA10WH	SA H/D J/WHEEL HANDLE TO SUIT SA10HD	
SA07	SINGLE LOCKING PIN BRACKET	
SA200X50	200 x 50 (8") CAST/POLY WHEEL	
SA250X60	250 x 60 (10") CAST/POLY WHEEL	



JW-HDLP

**8 x 2 HEAVY DUTY JOCKEY WHEEL
c/w SINGLE LOCKING PIN BRACKET**

STATIC CAPACITY (KG): 1500KG

J/WHEEL SPARE PARTS

PART NO.	DESCRIPTION	WEIGHT RATING	
323302-00	SINGLE LOCKING PIN BRACKET	--	
SRNW2005016	8 x 2 SOLID RUBBER WHEEL	800KG	
SRSW2504825	10 x 2 ALLI/RUBBER WHEEL	2000KG	
323307-01	EL. H/D JOCKEY WHEEL HANDLE (GRUB SCREW)	--	
323305-10	EL. H/D SCREWED SHAFT ONLY	--	
323306-10	EL. H/D SCREWED SHAFT NUT	--	

The AL-KO Landing Leg is the latest addition to AL-KO's extensive range of quality trailer components. Ideal for stabilising plant trailers, camper trailers, 5 wheeler caravans and agricultural equipment, the AL-KO Landing Leg is a necessary inclusion to the toolkit of the commercial contractor, farmer and camping enthusiast alike. All bases are covered with the AL-KO range of Landing Legs, with static loads ranging from 1,300 to 4,500kg. An AL-KO Landing Leg can also be fitted to another brands existing mounting kit. The AL-KO Landing Leg is your ideal choice when looking to safely and efficiently stabilise your trailer, camper, 5 wheeler caravan or agricultural machinery.

PART NO.	OUTER TUBE MM ²	TUBE MOUNT FITTED	WEIGHT KG	LOAD CAPACITY KG	SURFACE FINISH	A1	A2	B	C	D
622057	57.5RD	Yes	6.7	1300	Zinc	550	900	400	167	118
622057L	57.5RD	Yes	9.1	1300	Zinc	1060	1440	910	167	118
622070	70.0SQ	No	11.8	1500	Zinc	595	1275	-	167	118
622070WTM	70.0SQ	Yes	12.3	1500	Zinc	595	1275	-	167	118
622071	70.0SQ	No	9.9	2000	Zinc	580	940	-	167	118
622071WTM	70.0SQ	Yes	10.4	2000	Zinc	580	940	430	167	118
622110	110 SQ	No	32.9	4500	Zinc	690	1275	-	326	250
622000	Chassis Mount & Tube Bracket Kit				Zinc	-				



When rigid stability is required the AL-KO range of stands fits the bill. Available in varying heights and also in weld on swivel bracket versions.

These steady stands are ideal for fixed location stabilizing of trailers and plant equipment.

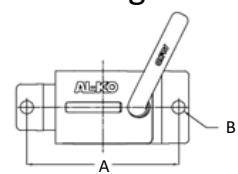
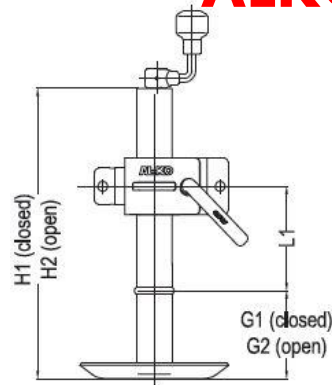

AS14

PART NO.	OUTER TUBE MM ²	TUBE MOUNT FITTED	WEIGHT KG	LOAD CAPACITY KG	SURFACE FINISH	H1	H2	G1	G2
AS14	48.0RD	N/A	4.5	400	Zinc	375	625	70	320



AS20

PART NO.	OUTER TUBE MM ²	TUBE MOUNT FITTED	WEIGHT KG	LOAD CAPACITY KG	SURFACE FINISH	H1	H2	G1	G2
AS20	48.0RD	N/A	5.0	400	Zinc	515	765	160	410



AS27

PART NO.	OUTER TUBE MM ²	TUBE MOUNT FITTED	WEIGHT KG	LOAD CAPACITY KG	SURFACE FINISH	H1	H2	G1	G2
AS27	48.0RD	N/A	6.0	400	Zinc	695	945	360	610

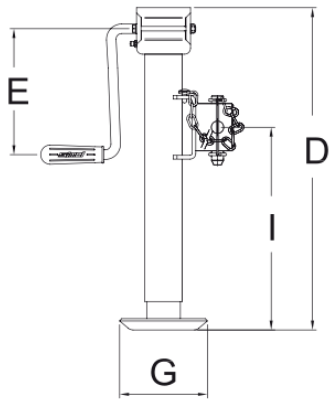

LT2103
51mm RD Side Wind Z/P Tube
Mount Stand no drop leg



LT3153
57mm RD Side Wind Z/P Tube
Mount Stand no drop leg

PART NO.	OUTER TUBE MM ²	WEIGHT KG	LOAD CAPACITY KG	D (mm)	E (mm)	G (mm)	I (mm)
LT2103	51 RD	5.6	900	430	168	120 x 140	280
LT3153	57 RD	7.1	1300	560	168	120 x 165	405

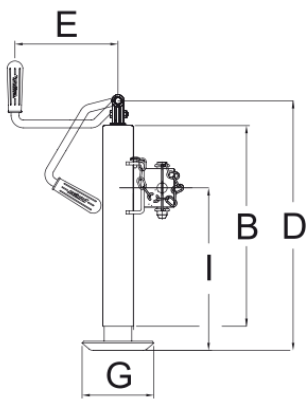

ST3154
57mm RD Top Wind Z/P Tube
Mount Stand no drop leg

PART NO.	OUTER TUBE MM ²	WEIGHT KG	LOAD CAPACITY KG	B (mm)	D (mm)	E (mm)	G (mm)	I (mm)
ST3154	57 RD	6.4	1300	455	535	168	120x165	390

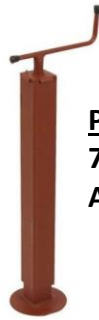
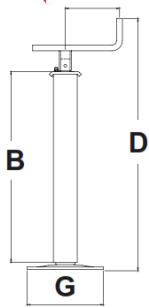

P560
70mm SQ Top Wind Red
Ag Stand no drop leg



P575
80mm SQ Top Wind Red
Ag Stand no drop leg

PART NO.	OUTER TUBE MM ²	WEIGHT KG	LOAD CAPACITY KG	B (mm)	D (mm)	E (mm)	G (mm)
P560	70 SQ	8.2	1000	500	670	185	160
P575	80 SQ	11	1200	500	670	185	200

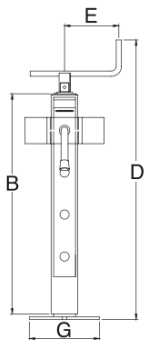

PE595
70mm SQ Top Wind Red Ag
Stand & Bracket no drop leg

PART NO.	OUTER TUBE MM ²	WEIGHT KG	LOAD CAPACITY KG	B (mm)	D (mm)	E (mm)	G (mm)
PE595	70 SQ	11.5	1000	500	670	185	160

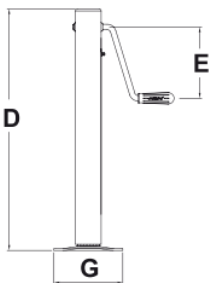

DG590
70mm SQ Side Wind Red Stand &
Bracket (no Drop Leg) 1500kg

PART NO.	OUTER TUBE MM ²	WEIGHT KG	LOAD CAPACITY KG	D (mm)	E (mm)	G (mm)
DG590	70 SQ	8.4	1500	530	175	120x165

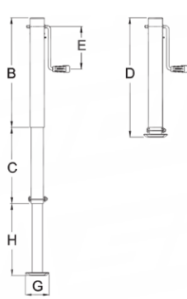

DG600/3SFW
70mm SQ Side Wind Zinc Plated
Stand c/w drop leg (3 stage wind)

PART NO.	OUTER TUBE MM ²	WEIGHT KG	LOAD CAPACITY KG	B (mm)	C (mm)	D (mm)	E (mm)	G (mm)	H (mm)
DG600/3SFW	70 SQ	11.9	2000	340	300	635	210	120x165	340

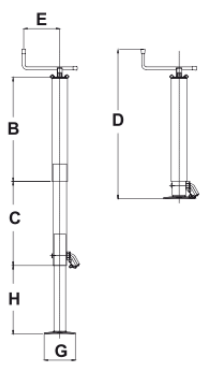

P575/3SF
80mm SQ Top Wind Red Ag Stand
c/w Drop Leg

PART NO.	OUTER TUBE MM ²	WEIGHT KG	LOAD CAPACITY KG	B (mm)	C (mm)	D (mm)	E (mm)	G (mm)	H (mm)
P575/3SF	80 SQ	16.7	1000	530	360	790	185	160	320

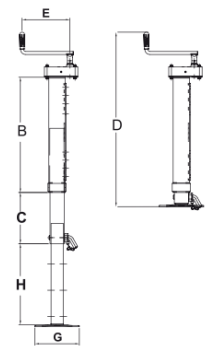

PR675/3SF1
80mm SQ Geared Top Wind Red
Ag Stand & Bracket c/w Drop Leg

PART NO.	OUTER TUBE MM ²	WEIGHT KG	LOAD CAPACITY KG	B (mm)	C (mm)	D (mm)	E (mm)	G (mm)	H (mm)
PR675/3SF1	80 SQ	20	2500	570	300	855	235	220	390

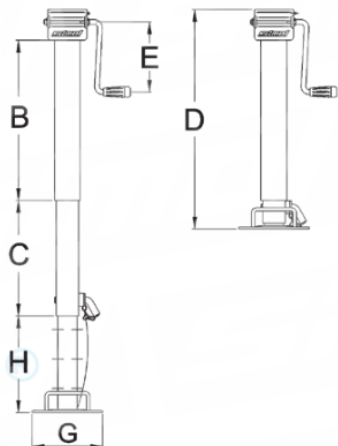

DG590/3SF
70mm Square Side Wind
Z/Plated Stand & Bracket
(c/w Drop Leg)



DG706/3SFW
80mm Squ. Side Wind Red Ag
Stand (c/w drop leg) (3 speed)







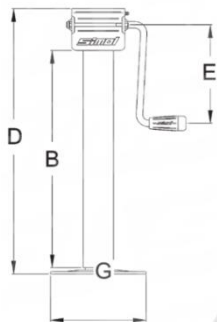

DG706/3SF
80mm Square Side Wind Red
Stand (c/w Drop Leg)

PART NO.	OUTER TUBE MM ²	WEIGHT KG	LOAD CAPACITY KG	B (mm)	C (mm)	D (mm)	E (mm)	G (mm)	H (mm)
DG590/3SF	70 SQ	12.5	1500	460	420	595	160	120x165	348
DG706/3SF	80 SQ	21	2500	500	290	685	225	220	276
DG706/3SFW	80 SQ	21	2500	500	290	685	225	220	276



DG706W
80mm SQ Side Wind Red Ag
Stand no drop leg (2 stage wind)

PART NO.	OUTER TUBE MM ²	WEIGHT KG	LOAD CAPACITY KG	B (mm)	D (mm)	E (mm)	G (mm)
DG706W	80 SQ	13.4	4000	500	620	225	220

PART NO.	DESCRIPTION	SUIT	
MS650	JACK HANDLE	LR3152/19	
F5	FLAT MOUNT PLATE	SQUARE STANDS	
LT/ST0141	WELD ON TUBE	LT2103 LT3153 LR3152/19 ST3154	
LT/ST0151	BOLT ON OR WELD ON TUBE	LR3152/19	
LF/SF0121	WELD ON PLATE	LF3151 SF3152	
040.02	MOUNT PLATE	H1140P	
SIM.DG706/ MAN	PVC HANDLE	PR675/3SF1; PE600; PE595; P560; P575; DG590; P575/3SF; DG706W; DG706/3SF; DG706/3SFW	

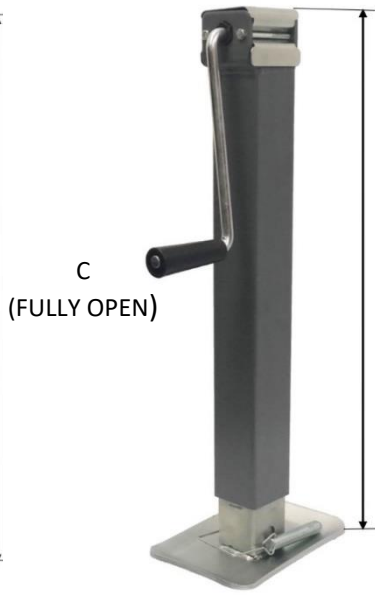
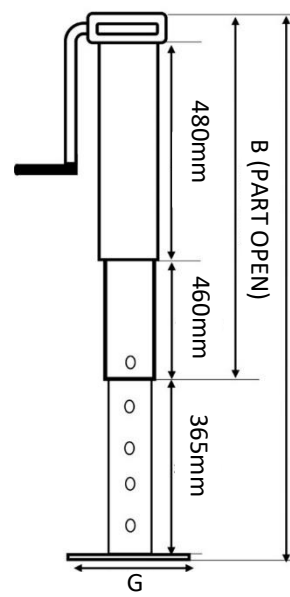

SABD-03E4
2 TON SIDE WIND STAND c/w
DROP LEG no TUBE MOUNT

OUTER TUBE (mm)	LOAD CAPACITY (KG)	SURFACE FINISH	A (CLOSED)	B (PART OPEN)	C (FULLY OPEN)	G
65mm(SQ)	2 TON	GREY	610mm	1020mm	1365mm	201mm x 140mm

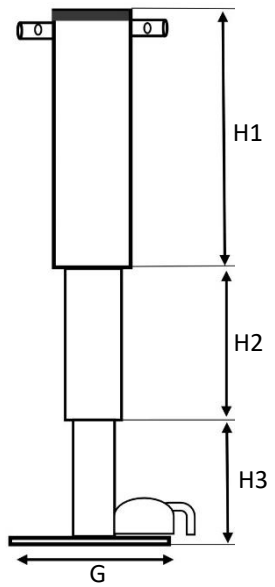

SAS45
4.5 TON ZINC PLATED STAND
c/w DROP LEG



OUTER TUBE (mm)	LOAD CAPACITY (KG)	SURFACE FINISH	D (CLOSED)	H1	H2	H3	G
105mm(SQ)	4.5 TON	ZINC	700mm	612mm	320mm	390mm	202 x 217mm



P/N 650300

AK WHEEL CLAMP

- Heavy duty weather resistant steel
- Anti-Scratch coating to protect your wheels
- Adjustable to suit 13-15" wheels
- Portable and easy to use
- Key operated lock



P/N BB27

PLASTIC BATTERY BOX (SMALL)

INTERNAL DIMENSION		
LENGTH (mm)	WIDTH (mm)	HEIGHT (mm)
275	180	200



P/N BB32

PLASTIC BATTERY BOX (LARGE)

INTERNAL DIMENSION		
LENGTH (mm)	WIDTH (mm)	HEIGHT (mm)
325	185	200

13Gal/59 Litre Camec Water Tank c/w Hose Fittings



PART NUMBER	REQUIRE HOSE FITTING	CAPACITY (Litre)	LENGTH (mm)	WIDTH (mm)	HEIGHT (mm)
033422	<ul style="list-style-type: none"> •033427 x 1 •005356 x 2 •006083 x 1 	59	865	490	190

18Gal/82 Litre Camec Water Tank c/w Hose Fittings



PART NUMBER	REQUIRE HOSE FITTING	CAPACITY (Litre)	LENGTH (mm)	WIDTH (mm)	HEIGHT (mm)
033423	<ul style="list-style-type: none"> •033427 x 1 •005356 x 2 •006083 x 1 	82	1220	490	190

12Gal/55 Litre Roto Camper Tank c/w Hose Fittings







PART NUMBER	REQUIRE HOSE FITTING	CAPACITY (Litre)	LENGTH (mm)	WIDTH (mm)	HEIGHT (mm)
006096	<ul style="list-style-type: none"> •006079 x 2 •005358 x 1 	55	760	355	230

14Gal/70 Litre Plastic Water Tank c/w Hose Fittings











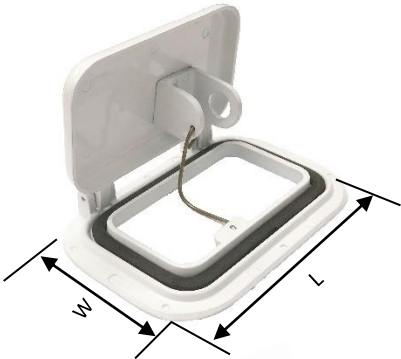



PART NUMBER	REQUIRE HOSE FITTING	CAPACITY (Litre)	LENGTH (mm)	WIDTH (mm)	HEIGHT (mm)
006099	<ul style="list-style-type: none"> •006079 x 1 •005358 x 1 	70	850	520	160





Spare Parts for Water Tanks

	033427	Barb to suit 59LTR & 82LTR Water Tank
	006079	Barb to suit 55LTR & 70LTR Water Tank
	005356	Hose Plug to suit 59LTR & 82LTR Water Tank
	005358	Hose Plug to suit 55LTR & 70LTR Water Tank
	006083	Breather to suit 59LTR & 82LTR Water Tank

	PART NO.	DESCRIPTION
	9017S	STAINLESS STEEL "T" FLUSH MOUNT LOCK
	22505	SMALL FLUSH MOUNT RING LASHES
	9193	LARGE FLUSH MOUNT RING LASHES
	10207B	BLACK PUSH BUTTON LOCK
	10207CP	CHROME PUSH BUTTON LOCK
	FU902	ZINC PLATE FLUSH MOUNT LOCK
	FU902SS	STAINLESS STEEL FLUSH MOUNT LOCK

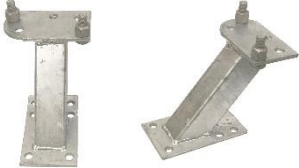
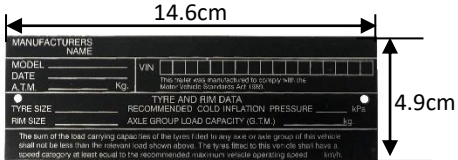
	PART NO.	DESCRIPTION
	ROV4P	SPINNING VENT 4" (PLASTIC) (AVAIL IN METAL)
	8018-400	SCUPPA VENT WHITE (SMALL) (L:16.6cm, W:11.2cm)
	8018-420	SCUPPA VENT WHITE (LARGE) (L:24cm, W:14.5cm)
	CLP00901	CLIPS TO SUIT HOLD DOWN CLAMP
	5202-011	HOLD DOWN CLAMP (LOCKABLE)
	5202-001	HOLD DOWN CLAMP (STANDARD)
	TH016	6" SPRING LOAD TAILGATE CATCH (EACH) (BOLT ON)
	GR100	GR. TAILGATE CATCH(PR) (WELD ON)

	PART NO.	DESCRIPTION
	BR100	SPRING LOADED TAILGATE CATCH (EACH) (WELD ON / BOLT ON)
	EDPM10	RUBBER WASHER TO SUIT DROP LOCKS
	DL	WELD ON DROP LOCKS (PR)
	DLB	BOLT ON DROP LOCKS (PR)
	E410SS	ELITE TAILGATE CATCH (PR) SMALL
	TGH	TAILGATE HINGES (PR)
	TGHG	GREASEABLE TAILGATE HINGES (PR)

	PART NO.	DESCRIPTION
	1532	SPARE WHEEL CARRIER (GALV) (TO SUIT FORD, HT HOLDEN & TLC(6))
	TIDP	TRAILER ID PLATE
	B5608	RACHET TIE DOWN – 500KG (25mm x 5metre)
	B5609	RACHET TIE DOWN – 1000KG (35mm x 6metre)
	B5601	RACHET TIE DOWN – 2500KG (50mm x 9metre)
	DS10	10mm RATED “D” SHACKLE (1 TON)
	DS11	11mm RATED “D” SHACKLE (1.5 TON)
	DS13	13mm RATED “D” SHACKLE (2 TON)

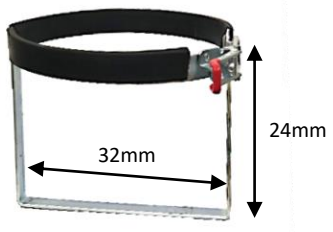
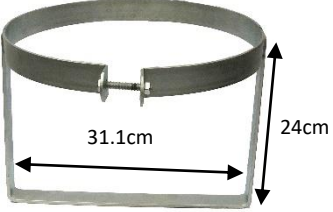
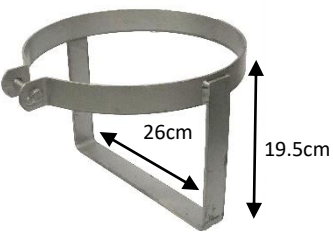
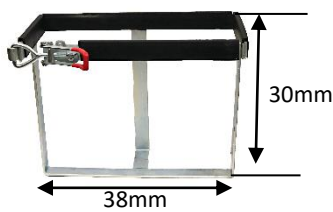
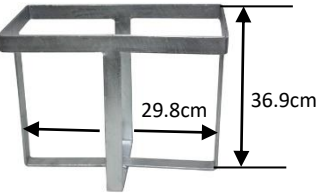
	PART NO.	DESCRIPTION
	345012-18	18" SINGLE CARAVAN STEP
	SAGBH-ADJ	ADJUSTABLE 9KG GAS BOTTLE HOLDER (LOCKABLE)
	345001-00	9KG GAS BOTTLE HOLDER
	345001-01	4.5KG GAS BOTTLE HOLDER
	SAJCH-ADJ	ADJUSTABLE JERRY CAN HOLDER (LOCKABLE)
	0091-031	JERRY CAN HOLDER

COUPLING

AL-KO

• FIXED COUPLING

This style of coupling, usually suited to a 50mm Australian Standard towball, is suitable to be used where either there are no brakes fitted to the trailer or the braking system does not require activation from a sliding or overrun coupling.

AL-KO couplings are simple to attach to the towball and provide safe secure attachment of the trailer to the tow vehicle.

Typical applications for domestic trailers are up to 750 kg ATM (total loaded mass), where no brakes are required. For independent brake systems such as electric or power operated like the IQ7 system for marine trailers over 2000 kg ATM (total loaded mass), a fixed coupling is the appropriate selection. Fixed couplings for 50mm towballs are suitable for up to 3500 kg ATM (total loaded trailer mass) as long as the appropriate braking system is fitted to the trailer.

					
PART NUMBER	616200	614060	614075	614755	614010
DESCRIPTION	PRESS STEEL COUPLING	2 HOLE COUPLING	3 HOLE COUPLING	LEVER COUPLING	ELECTRIC COUPLING & LEVER
WEIGHT RATING	750kg	2000kg	2000kg	2000kg	3500kg
SUITS TOWBALL SIZE	50mm	50mm	50mm	50mm	50mm
MOUNTING HOLE (LXW) & DIAMETER	90mm x 12.2mm	101.6mm x 13.5mm	111.1mm x 51mm x 13.5mm	90mm x 36mm x 11mm	182.5mm x 55mm x 13.5mm
SURFACE FINISH	ZINC PLATED	PAINTED	ZINC PLATED	DACROMET	ZINC PLATED
BALL TO FIRST CENTRE HOLE (NOMINAL)	110mm	77mm	67mm	95mm	128mm

Helpful Hint: Use high tensile mounting bolts on all fixed couplings!

COUPLING

AL-KO

• OVER-RIDE COUPLING

On trailers between 750 kg and 2000 kg total laden mass, braking systems that use an override principal are acceptable, as long as they provide adequate braking for the trailer and tow vehicle combination.

The principal of this type of coupling is a sliding shaft attached to the tow ball housing of the coupling, and as the tow vehicle slows down the force of deceleration is passed through the coupling shaft and pushed either on a mechanical linkage (for mechanical brakes) or acts on a linkage connected to a hydraulic cylinder providing hydraulic pressure to a braking system (hydraulic brakes).

This type of coupling is efficient if the ball load is not excessive and when load levelling devices are not used, as these devices impede the smooth operation of the coupling, impeding the brake performance.



PART NUMBER	614040	614042	614050	614054
DESCRIPTION	HYDRAULIC OVER-RIDE COUPLING & 19mm MASTER CYLINDER	HYDRAULIC OVER-RIDE COUPLING & 22mm MASTER CYLINDER	MECHANICAL OVER-RIDE COUPLING & LEVER	MECHANICAL OVER-RIDE COUPLING ONLY
WEIGHT RATING	2000kg	2000kg	2000kg	2000kg
SUITS TOWBALL SIZE	50mm	50mm	50mm	50mm
MOUNTING HOLE (LXW) & DIAMETER	184mm x 54mm x 13.5mm	184mm x 54mm x 13.5mm	184mm x 54mm x 13.5mm	184mm x 54mm x 13.5mm
SURFACE FINISH	ZINC PLATED	ZINC PLATED	ZINC PLATED	ZINC PLATED
BALL TO FIRST CENTRE HOLE (NOMINAL)	137mm	137mm	137mm	137mm

COUPLING

AL-KO

• FIXED RING COUPLING

When used in a commercial or defence department application, often a 75 mm ring type towing eye is requested.

This style of coupling is similar in function to ball type couplings (fixed and over ride) but instead of the connection to the tow vehicle being a standard 50 mm ball, the connection is a 75 mm inside diameter ring and this attaches to a "pintle hook" fitted to the tow vehicle. These types of couplings are primarily used in applications where the tow vehicle is a heavy commercial truck. As the Australian Standard AS4177 states the 50mm towball to have a maximum capacity of 3500 kg ATM (total loaded mass), ring couplings are used when higher loads are involved.

PART NUMBER	614304	614309
DESCRIPTION	3" RING FIXED COUPLING (3 HOLE)	3" RING FIXED COUPLING (4 HOLE)
WEIGHT RATING	3500kg	6000kg
RING SIZE	75mm	75mm
MOUNTING HOLE (LXW) & DIAMETER	103mm x 56mm x 16.8mm	182mm x 52mm x 16.8mm
SURFACE FINISH	ZINC PLATED	ZINC PLATED
BALL TO FIRST CENTRE HOLE (NOMINAL)	86mm	116mm

COUPLING



AL-KO

• OFF-ROAD COUPLING

When a coupling is used for rough off-road use the Australian Standard degree of articulation (or angles of available movement) may be insufficient. AL-KO has solved this problem with the AL-KO Off Road Coupling. When off-road 4WD vehicles tow trailers in rugged outback conditions it is advisable that a coupling specifically designed to have greater angular movement is used.

The AL-KO Off Road Coupling with 360 degree articulation and positive towball latching system offer the maximum degree of articulation as well as a design that has been tested to 2 million fatigue test cycles, so you know that it will pass all tests.

AL-KO has a range of suitable "off-road" couplings in both fixed and override functions to provide the appropriate articulation for this use.

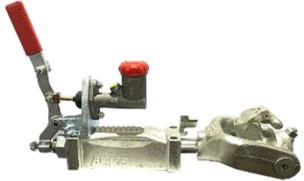
				
PART NUMBER	619350	619200	619200/53	619200/43
DESCRIPTION	ELECTRIC SWIVEL OFF-ROAD COUPLING (NON-OVER-RIDE) (NEW STYLE)	OVER-RIDE OFF-ROAD COUPLING ONLY (NEW STYLE)	MECHANICAL OVER-RIDE OFF-ROAD COUPLING & LEVER (NEW STYLE)	HYDRAULIC OVER-RIDE OFF-ROAD COUPLING & 19mm MASTER CYLINDER (NEW STYLE)
WEIGHT RATING	3500kg	2000kg	2000kg	2000kg
SUITS TOWBALL SIZE	50mm	50mm	50mm	50mm
MOUNTING HOLE (LXW)	184mm x 54mm	184mm x 54mm	184mm x 54mm	184mm x 54mm
SURFACE FINISH	ZINC PLATED	ZINC PLATED	ZINC PLATED	ZINC PLATED

COUPLING

AL-KO

• OFF-ROAD PIN COUPLING

Innovative market leader AL-KO has taken ease of use to a new level with the release of the AL-KO Off-Road Pin Coupling featuring their new patent pending Click Lock™ system.



With the development of Click Lock, AL-KO now offers an off-road pin coupling that is self-locking – automatically completing the primary and secondary locking required for ADR compliance, with no additional action required by the user. The result is hands free hitching, making it safer and easier to use than other pin couplings on the market. To hitch up, simply lower the coupling over the pin. An integrated positive latching indicator confirms that you are ready to go when it clicks into place.

AL-KO's unique forged yoke allows maximum articulation on both horizontal and vertical planes sustained up to 3500kg ATM. A built in cover makes the coupling completely sealed from the elements with no loose parts, levers or dust caps. The product has the lowest profile of any pin coupling on the market at just 83mm, making it ideal for tow vehicles with barn doors.

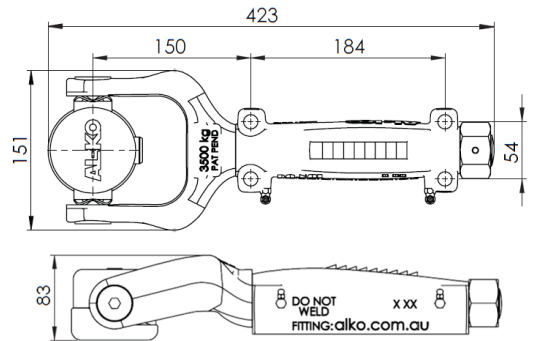
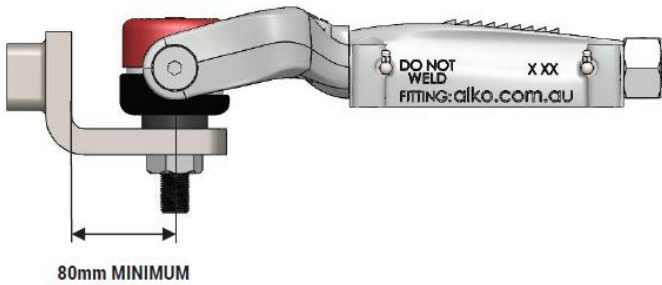
	PART NUMBER	DESCRIPTION	WEIGHT RATING	MOUNTING HOLE (LXW) & DIAMETER	SURFACE FINISH	PIN TO FIRST CENTRE HOLE (NOMINAL)
	619400	OFF-ROAD PIN COUPLING c/w PIN	3500 kg	184 x 54mm	ZINC PLATED	150 mm

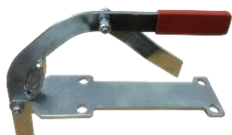

SPARE PARTS to suit ABOVE COUPLING:

	PART NUMBER	DESCRIPTION
	619410	PIN to suit OFF-ROAD PIN COUPLING
	619411	COVER to suit PIN
	614055	BASE PLATE & LEVER suit AK PIN COUPLING ONLY (184 x 54 x 13.5mm)

COUPLING

AL-KO

• SWAY CONTROL COUPLING

AL-KO has a specific coupling designed to reduce trailer sway. This 50mm ball type fixed coupling is designed to be used on trailer up to 2500 kg ATM (total loaded mass) and with a maximum towball weight of 250 kg.



This unique product incorporates a clamping system that grips the sides of a specially designed 50 mm tow ball and resists movement of the trailer. This action slows down any tendency for the trailer to sway or veer from a straight condition.

This is particularly a benefit when large trailers such as caravans are buffeted by side winds or by a passing truck and trailer combination.

****NOTE: This type of coupling must only be used with a 50mm ball which has an anti-rotation plate for attachment to the vehicle fitted.****

	PART NUMBER	DESCRIPTION	WEIGHT RATING	SUITS TOWBALL SIZE	MOUNTING HOLE (LXW) & DIAMETER	SURFACE FINISH	BALL TO FIRST CENTRE HOLE (NOMINAL)
	618000	AKS 3000 STABILIZER COUPLING	2500kg	50mm	184mm x 54mm x 13.5mm	ZINC PLATED	203mm

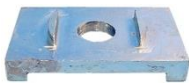
SPARE PARTS to suit ABOVE COUPLING:

	PART NUMBER	DESCRIPTION	SUITS TOWBALL SIZE	SIZE
	618100	RETENSION PLATE to suit AKS 2000 & 3000	50mm	75mm WIDE
	618901	AKS 3000 HIGH RISE TOWBALL	50mm	—
	618904	AKS 3000 STANDARD TOWBALL	50mm	—

COUPLING

AL-KO

	PART NUMBER	DESCRIPTION	SURFACE FINISH	MOUNTING HOLE (LXW) & DIAMETER
	P6575	19mm or 3/4" MASTER CYLINDER ONLY	--	--
	P7890	22mm or 7/8" MASTER CYLINDER ONLY	--	--
	619043	MASTER CYLINDER MOUNT BRACKET c/w 19mm MASTER CYLINDER	ZINC PLATED	--
	610944	MASTER CYLINDER MOUNT BRACKET c/w 22mm MASTER CYLINDER	ZINC PLATED	--
	614053	MECHANICAL BASE PLATE & LEVER	ZINC PLATED	184mm x 54mm x 13.5mm

COUPLING

TRIGG BROS

- **FIXED COUPLING**



A1503

**50mm 3 HOLE COUPLING
c/w ADJUSTER**

WEIGHT RATING: 2000KG

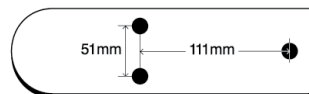

A900

**50mm ELECTRIC COUPLING
c/w LEVER**

WEIGHT RATING: 3500KG

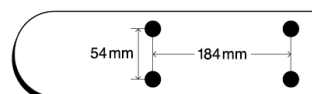

COUPLING

TRIGG BROS

- **OVER-RIDE COUPLING**

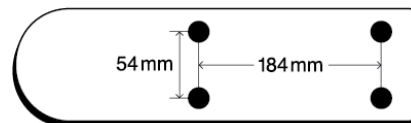

A800-H

**50mm MECHANICAL OVER-RIDE
COUPLING ONLY**

WEIGHT RATING: 2000KG



A800-807

**50mm MECHANICAL OVER-RIDE
COUPLING c/w LEVER**

WEIGHT RATING: 2000KG



A800-01

**50mm HYDRAULIC OVER-RIDE
COUPLING c/w 19mm CYLINDER**

WEIGHT RATING: 2000KG

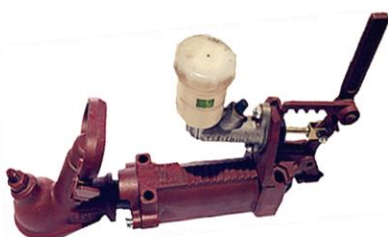

A800-02

**50mm HYDRAULIC OVER-RIDE
COUPLING c/w 22mm CYLINDER**

WEIGHT RATING: 2000KG

COUPLING

TRIGG BROS

• RING COUPLING



A760

3" RING FIXED COUPLING (3 HOLE)

WEIGHT RATING: 3000KG

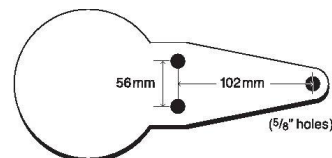

A795

3" RING FIXED COUPLING (4 HOLE)

WEIGHT RATING: 6000KG

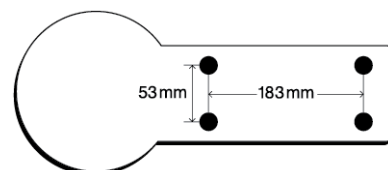

A790

3" RING MECHANICAL OVER-RIDE COUPLING c/w LEVER

WEIGHT RATING: 2000KG

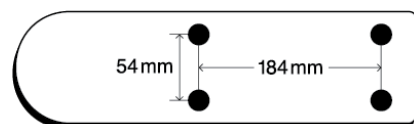

A790-02

3" RING HYDRAULIC OVER-RIDE COUPLING c/w 19mm CYLINDER & ANTI SWIVEL PLATE

WEIGHT RATING: 2000KG

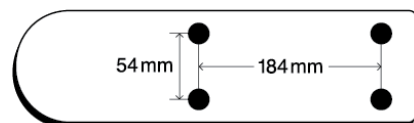

COUPLING

TRIGG BROS

• POLYBLOCK COUPLING

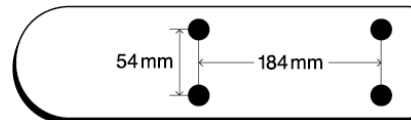

PB700

POLYBLOCK MECHANICAL OVER-RIDE COUPLING ONLY

WEIGHT RATING: 2000KG

PB700-807

POLYBLOCK MECHANICAL OVER-RIDE COUPLING c/w LEVER

WEIGHT RATING: 2000KG

PB700-01

POLYBLOCK HYDRAULIC OVER-RIDE COUPLING c/w 19mm CYLINDER

WEIGHT RATING: 2000KG





PB750

POLYBLOCK SWIVEL COUPLING ONLY

WEIGHT RATING: 3000KG

COUPLING

TRIGG BROS

	PART NUMBER	DESCRIPTION
	A803ASS	MASTER CYLINDER MOUNT BRACKET, LEVER & CATCH
	A803-34	MASTER CYLINDER MOUNT BRACKET c/w 19mm CYLINDER
	A803-78	MASTER CYLINDER MOUNT BRACKET c/w 22mm CYLINDER
	A807	MECHANICAL BASE PLATE & LEVER to suit BALL COUPLING
	A790/MBP	MECHANICAL ANTI SWIVEL BASE PLATE & LEVER to suit RING COUPLING
	A790/HBP	HYDRAULIC ANTI SWIVEL BASE PLATE & LEVER to suit RING COUPLING
	PB701/706	POLYBLOCK 19mm CAR FITTING & PIN

MACHINE BALL



TB178C

1.7/8" MACHINE BALL - 2" x 7/8" SHANK

TOWING CAPACITY: 2270KG

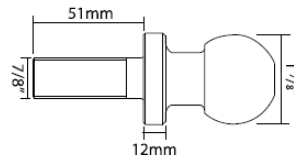

TB35C

50mm MACHINE BALL - 2" x 7/8" SHANK
(TESTED & PASSED IN AUSTRALIA TO AS 4177.2-2004)

TOWING CAPACITY: 3500KG

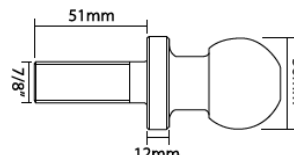

TB3562Z

50mm MACHINE BALL - 2.5" x 7/8" SHANK

TOWING CAPACITY: 3500KG

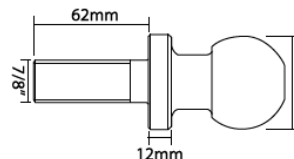

TB5080C

50mm MACHINE BALL - 3" x 7/8" SHANK

TOWING CAPACITY: 2500KG

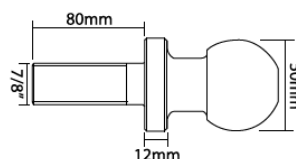

TB503T

50mm MACHINE BALL - 2" x 1" SHANK

TOWING CAPACITY: 3500KG

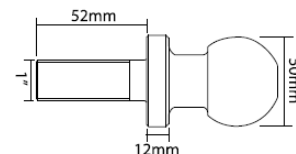



JS-CWET

50mm A-FRAME WELD ON COUPLING



AO118

3" RING WELD ON SWIVEL COUPLING

WEIGHT RATING: 5000KG



AO160

3" RING BOLT ON TELECOM COUPLING

WEIGHT RATING: 8000KG

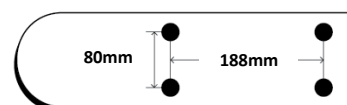

COUPLING

• CARTER WESCO

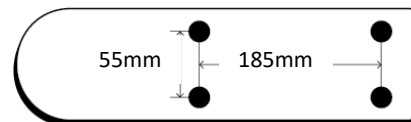

WF6

70mm BALL COUPLING c/w LEVER

WEIGHT RATING: TESTED TO 6000KG



W46/6

70mm BALL to suit 70mm COUPLING

WEIGHT RATING: TESTED TO 6000KG

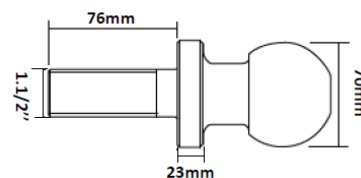

• COUPLMATE

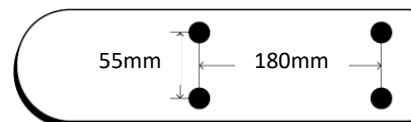

WF45

70mm BALL COUPLING c/w LEVER

WEIGHT RATING: TESTED TO 4500KG



W46

70mm BALL to suit 70mm COUPLING

WEIGHT RATING: TESTED TO 4500KG

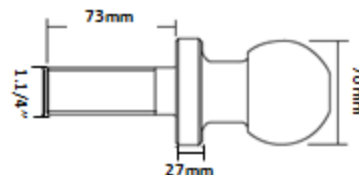

COUPLING

TREG

- **POLYBLOCK SWIVEL COUPLING**



PB75F

**POLYBLOCK SWIVEL COUPLING ONLY
to suit 3/4" PIN (WELD ON)**

WEIGHT RATING: 3000KG



PB75FHD

**POLYBLOCK SWIVEL COUPLING ONLY
to suit 1" PIN (WELD ON)**

WEIGHT RATING: 3500KG

COUPLING

TREG

- **POLYBLOCK OVER-RIDE COUPLING**

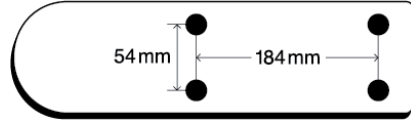

PBMORO

POLYBLOCK MECHANICAL OVER-RIDE COUPLING ONLY

WEIGHT RATING: 2000KG

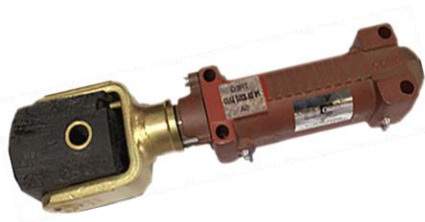

PBMOR

POLYBLOCK MECHANICAL OVER-RIDE COUPLING c/w LEVER

WEIGHT RATING: 2000KG

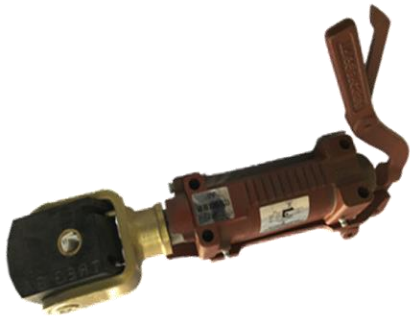

PBHOR19







POLYBLOCK HYDRAULIC OVER-RIDE COUPLING c/w 19mm CYLINDER

WEIGHT RATING: 2000KG



COUPLING

TREG

	PART NUMBER	DESCRIPTION
	PBCFP19	CAR FITTING & 3/4" PIN (suit car)
	PBCFP25	CAR FITTING & 1" PIN (suit car)
	PB7575	STD POLYBLOCK ONLY
	PBY	YOKE FOR POLYBLOCK
	PBSLP19	3/4" SPRING LOADED PIN c/w CLIP
	PBSLP25	1" SPRING LOADED PIN c/w CLIP
	PBLP	LINCH PIN

COUPLING

• GOOSE NECK COUPLING & BALLS



SM300C

SM300 3" GOOSE NECK COUPLING

WEIGHT RATING: 9000KG



GP300C

GP300 3" GOOSE NECK COUPLING

WEIGHT RATING: 9000KG



B2516

2.5/16" TOWBALL

TOWING RATING: 6000KG

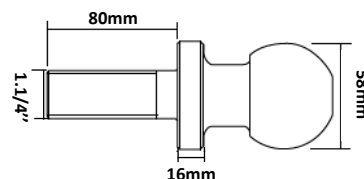

SM300B

SM300 3" TOWBALL

TOWING RATING: 9000KG

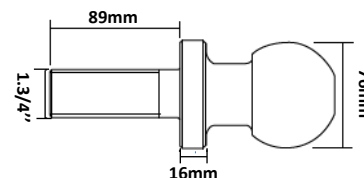

COUPLING BARTLETT

• 95mm BALL TRAILER COUPLING

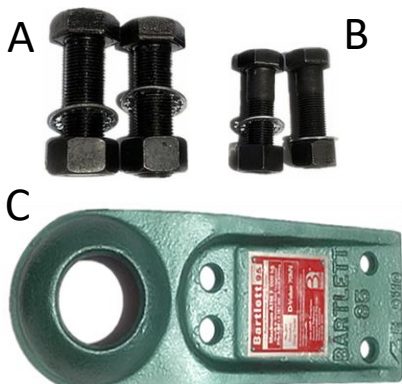

375AX

95mm TRAILER COUPLING

RIGID DRAWBAR: MAX. ATM 7000KG

HINGED DRAWBAR: D-VALUE 70KN

(INCL.: A - 375/11 1" BOLT SET;

B - 375/10 3/4" BOLT SET;

C - 375/1 TRAILER HOOD)



375DX

95mm BALL & TRUCK KIT

RIGID DRAWBAR: MAX. ATM 7000KG

HINGED DRAWBAR: D-VALUE 70KN

(INCL: A - 5-3/9 SAFETY SPRING;

B - 375/6 CLAMPING BOLT;

C - 375/7 COMPRESSION SPRING;

D - 375/3 CAP;

E - 375/4 MAIN BOLT;

F - 375/2 BALL;

G - 5-3/5 NYLOC NUT & WASHER)



COUPLING BARTLETT

• 95mm BALL TRAILER COUPLING

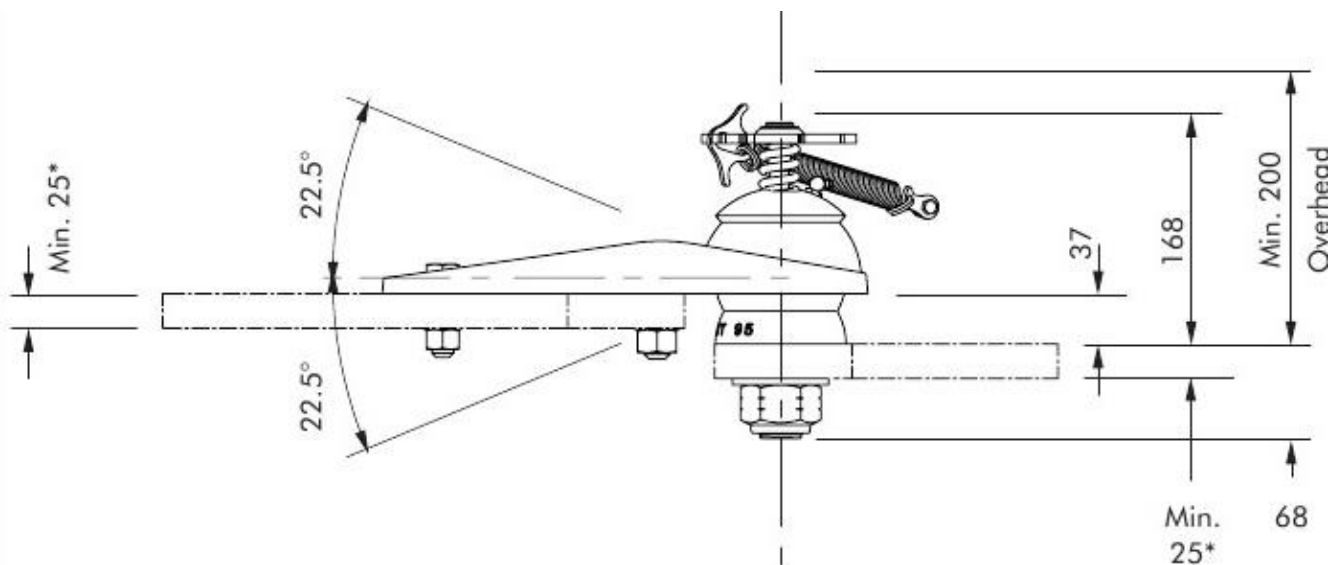
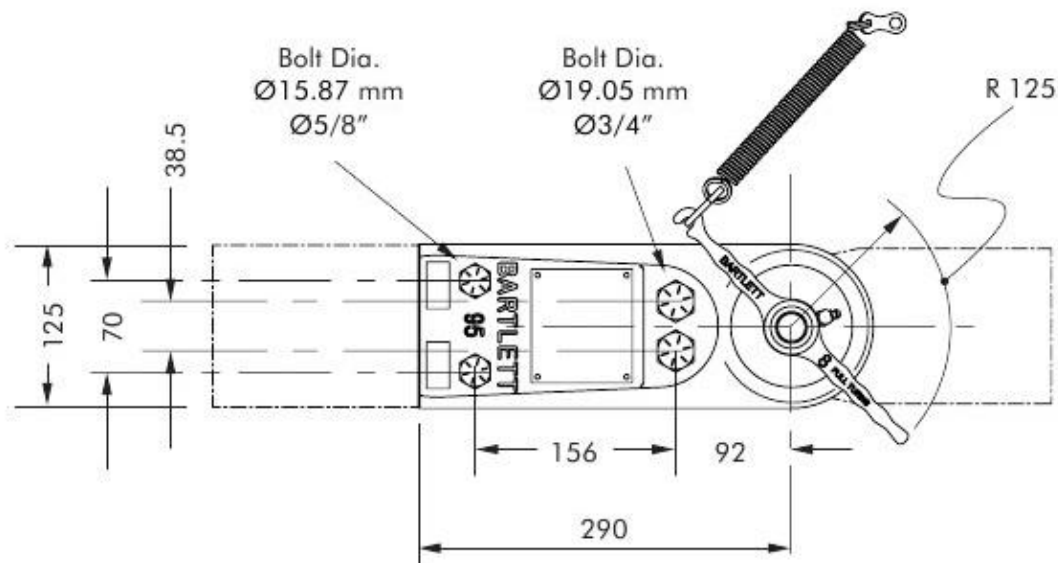

Do not scale - All measurements in mm

*Mounting lugs not included, shown for illustration purpose only - available at extra cost

*Mounting lugs must be adequately supported as dictated by professional design engineer

*DWG or DXF file available approval

COUPLING

BARTLETT

• 127mm BALL TRAILER COUPLING



59AX

127mm TRAILER COUPLING

RIGID DRAWBAR: MAX. ATM 24000KG

HINGED DRAWBAR: D-VALUE 155KN

(INCL.: A - 59/11 1" BOLT SET;

B - 59/10 3/4" BOLT SET;

C - 59/1 TRAILER HOOD)



59DX

127mm BALL & TRUCK KIT

RIGID DRAWBAR: MAX. ATM 24000KG

HINGED DRAWBAR: D-VALUE 155KN

(INCL: A - 5-3/9 SAFETY SPRING;

B - 59/6 CLAMPING BOLT;

C - 59/7 COMPRESSION SPRING;

D - 59/3 CAP;

E - 59/4 MAIN BOLT;

F - 59/2 BALL;

G - 59/8 LOCATING RING;

G - 5-3/5 NYLOC NUT & WASHER)



COUPLING BARTLETT

• 127mm BALL TRAILER COUPLING

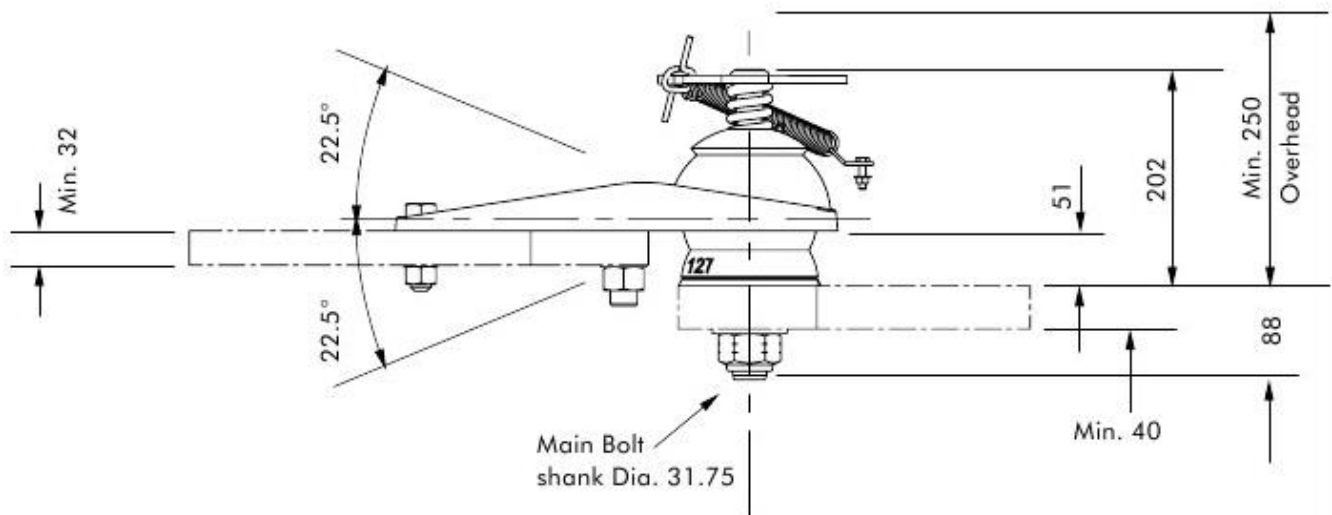
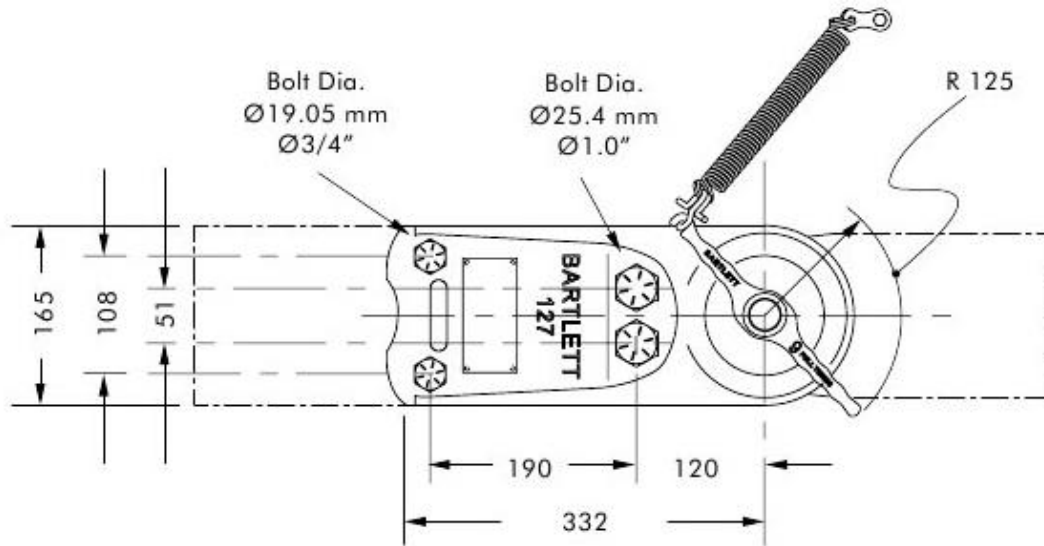

Do not scale - All measurements in mm

*Mounting lugs not included, shown for illustration purpose only - available at extra cost

*Mounting lugs must be adequately supported as dictated by professional design engineer

*DWG or DXF file available approval

COUPLING

BARTLETT

• SAFE-T-CHAIN SYSTEM

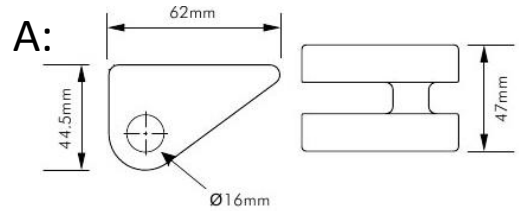

SC62-13R

TOWBAR CHAIN BRACKET SET

CAPACITY: MAX. ATM 13500KG

(INCL.: A - ATTACHMENT - HIGH TENSILE WELDABLE STEEL (2 OFF) (DIMENSIONS SEE

ABOVE SCETCHES);

B - DRAWPIN ASSEMBLY - HIGH TENSILE (2 OFF);

C - DRAWPIN KEEPER (2 OFF))

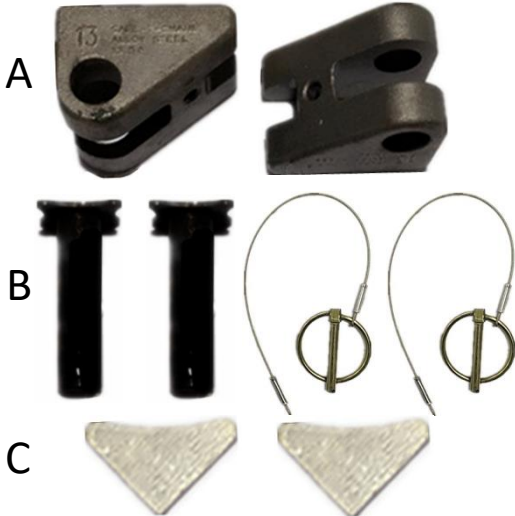

SC62-13F

TRAILER CHAIN BRACKET SET

CAPACITY: MAX. ATM 13500KG

(INCL.: A - ATTACHMENT - HIGH TENSILE WELDABLE STEEL (2 OFF) (DIMENSIONS SEE

ABOVE SCETCHES);

B - TRAILER PIN ASSEMBLY - HIGH TENSILE (2 OFF))



TB800/13-20

13mm x 790mm CHAIN SET

(2 LENGTHS)



COUPLING ACCESSORIES



0141-101

COUPLE-MATE BALL ATTACHMENT AID



TBS41B

TOWBALL MULTI SPANNER (BL PACK)



619100

AK ZINC PLATED HANDBRAKE LEVER



D1090

3" MARINE BASE PLATE & LEVER



D1093

4" MARINE BASE PLATE & LEVER

- **COUPLMATE**



CM051

DUAL COUPLING LOCK



CM061

HITCH PIN LOCK - 5/8" x 65mm



CM062

HITCH PIN LOCK - 5/8" x 85mm



CM056

TREG SPRING LOADED PIN c/w LOCK

PINTLE HOOK

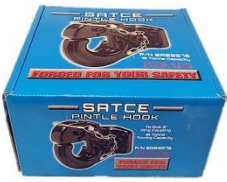

• SA PINTLE HOOK ONLY

	PART NUMBER	PARTS IN THE BOX	MODEL NUMBER	CRN	STATIC RATING (KG)
	SA89676	<ul style="list-style-type: none"> • PINTLE HOOK • BOLTS, NUTS & WASHERS • FITTING INSTRUCTION • TAG 	PH-10000	44545	10000kg



• SA PINTLE HOOK c/w BALL

	PART NUMBER	PARTS IN THE BOX	MODEL NUMBER	CRN	STATIC RATING (KG)
	SA89758	<ul style="list-style-type: none"> • PINTLE HOOK c/w BALL • BOLTS, NUTS & WASHERS • FITTING INSTRUCTION • TAG 	PH6000/ TB3500	44543 & 44544	<ul style="list-style-type: none"> • HOOK: 6000kg • BALL: 3500kg

• SA PINTLE HOOK RECEIVER



	PART NUMBER	PARTS IN THE BOX	MODEL NUMBER	CRN	STATIC RATING (KG)
	SA69021	<ul style="list-style-type: none"> • PINTLE HOOK RECEIVER • FITTING INSTRUCTION • TAG 	PHEP6000	44737	6000kg

PART NO.	DESCRIPTION	
90195	TEKONSHA P3 Hand controller Suit: 1 - 4 Axles with Brakes Dimension: 3" L x 4.5" W x 10.63" H Weight: 0.68 kg	
90885	TEKONSHA P2 Hand controller Suit: 1 - 4 Axles with Brakes Dimension: 4.5" L x 3" W x 10.50" H Weight: 0.56 kg	
90155	TEKONSHA PRIMUS Hand controller Suit: 1 - 3 Axles with Brakes Dimension: 2.5" L x 4.5" W x 8.5" H Weight: 0.57 kg	
90160	TEKONSHA PRIMUS IQ Hand controller Suit: 1 - 3 Axles with Brakes Dimension: 2.5" L x 4.5" W x 8.5" H Weight: 0.57 kg	
7686	PRODIGY Pocket Mount Kit	
333064	PRIMUS Pocket Mount Kit	
7894	PRODIGY Wiring Loom	
2801	Active Fab Brake Controller Suit: 1 - 2 Axles with Brakes Dimension: 95mm L x 58mm W x 30mm H Weight: 0.174 kg	
EBRH-ACCV3	REDARC Tow-Pro Elite Electric Brake Controller	

BREAK-AWAY UNITS

BREAKSAFE



4024

SA6000 BREAKSAFE UNIT

- TO SUIT 2 & 4 WHEEL BRAKE
- INCLUDING:
 - 1 OFF NP7 12V BATTERY
 - 1 OFF BREAKAWAY SWITCH c/w COIL CABLE
 - SET OF MOUNTING HARDWARE
 - INSTALLATION INSTRUCTION BOOK







4068

SA6000XP BREAKSAFE UNIT

- TO SUIT 6 WHEEL BRAKE
- INCLUDING:
 - 1 OFF NP9 12V BATTERY
 - 1 OFF BREAKAWAY SWITCH c/w COIL CABLE
 - SET OF MOUNTING HARDWARE
 - INSTALLATION INSTRUCTION BOOK

BREAKSAFE

	PART NUMBER	DESCRIPTION
	SA5000RM	5000 REMOTE MONITORS
	BAT	REPLACEMENT BREAKSAFE BATTERY 7 A/H - TO SUIT SA6000
	BATXP	REPLACEMENT BREAKSAFE BATTERY 9 A/H - TO SUIT SA6000XP
	SA0172W	REPLACEMENT COIL CABLE & PIN
	SA0172	REPLACEMENT BREAKAWAY SWITCH c/w COIL CABLE

ELECTRIC BREAK-AWAY SYSTEM









SA7000 StaySAFE UNIT

- TO SUIT 2000 – 4499KG ON 2, 4 & 6 WHEEL BRAKE
- PASSED TEST IN AUSTRALIA TO ADR38/04 SPECIFICATIONS
- COMPLIES WITH ADR38/04 AUSTRALIA WIDE (REMOTE MONITOR FOR NSW)
- INCLUDING:
 - A - StaySAFE CONTROL UNIT WITH HEAVY DUTY 12V BATTERY (1 OFF)
 - B - StaySAFE REMOTE BATTERY LEVEL MONITOR (1 OFF)
 - C - StaySAFE 240V to 12V BATTERY CHARGER (1 OFF)
 - D - StaySAFE BREAKAWAY SWITCH c/w LANYARD & CLIP (1 OFF)
 - COMPREHENSIVE INSTRUCTION BOOK (1 OFF)
- SPARE PARTS AVAILALE

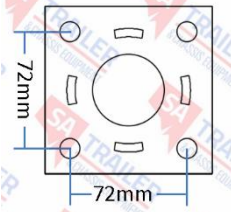

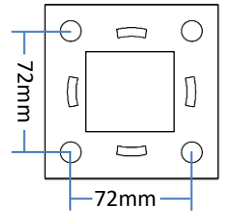
ELECTRIC BRAKE SPARE PARTS

- to suit 10" ELECTRIC BRAKE

		PART NUMBER	DESCRIPTION
		332100S	STD ELECTRIC MOUNT PLATE – 39mm ROUND HOLE
		332150B	H/DUTY ELECTRIC MOUNT PLATE – 45mm ROUND HOLE
		FE10S42	ELECTRIC MOUNT PLATE to suit 40mm SQUARE AXLE – 42mm SQUARE HOLE
		FE10S47	ELECTRIC MOUNT PLATE to suit 45mm SQUARE AXLE – 47mm SQUARE HOLE
		FE10S52	ELECTRIC MOUNT PLATE to suit 50mm SQUARE AXLE – 52mm SQUARE HOLE

NOTE: FOR BEST RESULTS, USE JIG TO FIT MOUNT PLATES

ELECTRIC BRAKE

• 10" & 12" ELECTRIC BACKPLATE – AL-KO

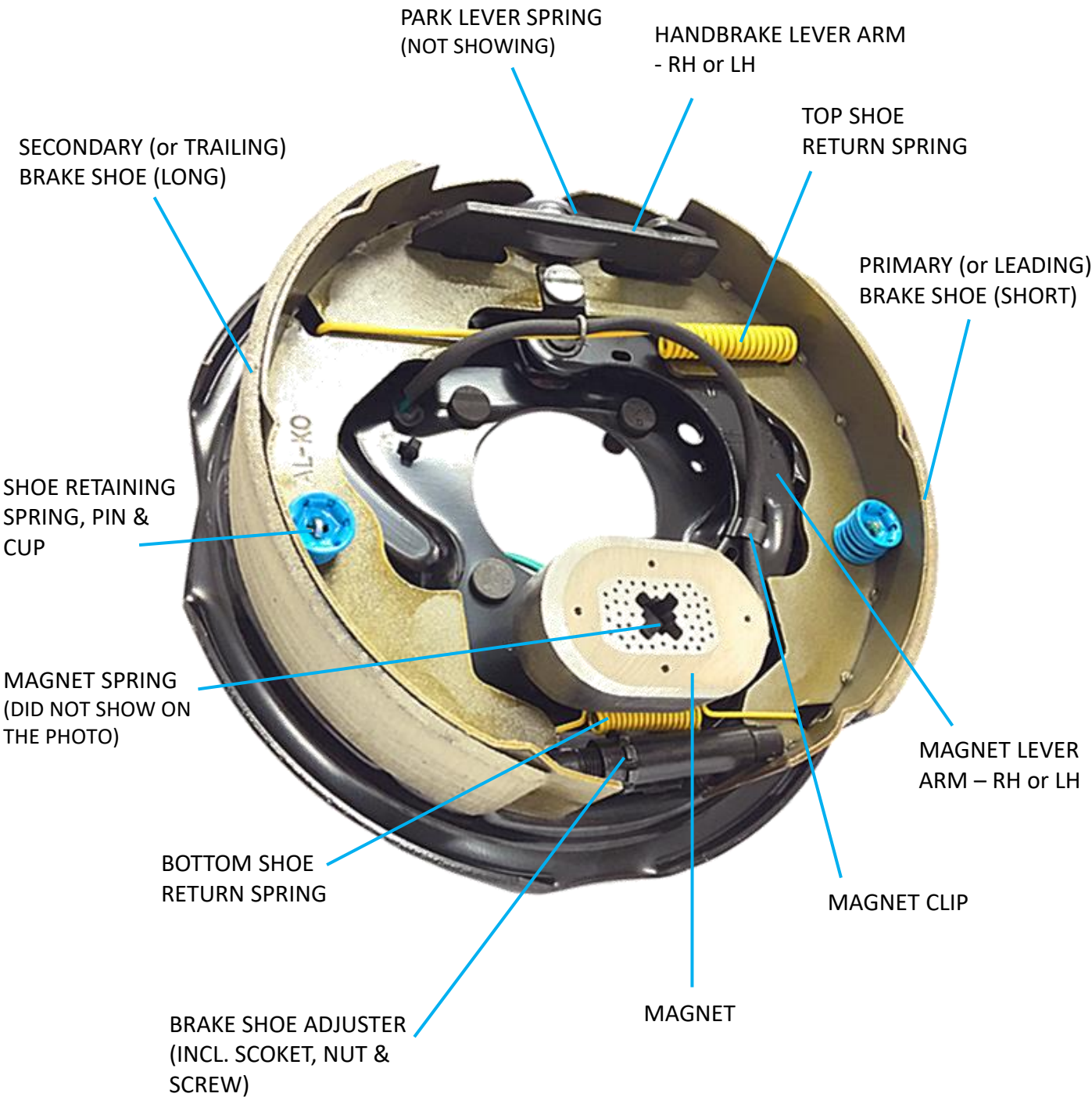

NOTE: SAMPLE BASED ON THE AK 10" RH ELECTRIC BACKPLATE

ELECTRIC BRAKE SPARE PARTS

- to suit 10" ELECTRIC BACKPLATE – AL-KO

	PART NUMBER	DESCRIPTION
	339010	AK 10" OVAL MAGNET KIT (BL PACK – incl. MAGNET, CLIP & SPRING)
	339118	AK 10" OVAL MAGNET (LOOSE)
	339015	AK 10" OVAL OFFROAD MAGNET KIT – R/H (BL PACK – incl. MAGNET, CLIP & SPRING)
	339020	AK 10" OVAL OFFROAD MAGNET KIT – L/H (BL PACK – incl. MAGNET, CLIP & SPRING)
	339255	AK 10" OVAL OFF-ROAD MAGNET – R/H (LOOSE)
	339250	AK 10" OVAL OFF-ROAD MAGNET – L/H (LOOSE)

ELECTRIC BRAKE SPARE PARTS

- to suit 10" ELECTRIC BACKPLATE – AL-KO

	PART NUMBER	DESCRIPTION
	339115	AK 10" MAGNET LEVER ARM – R/H
	339114	AK 10" MAGNET LEVER ARM – L/H
	339120/1	PAIR AK 10" ELECTRIC BRAKE SHOES to suit 1 WHEEL
	339132	AK HANDBRAKE LEVER ARM – R/H to suit 10" & 12"
	339131	AK HANDBRAKE LEVER ARM – L/H to suit 10" & 12"

ELECTRIC BRAKE SPARE PARTS

• to suit 10'' ELECTRIC BACKPLATE – AL-KO

	PART NUMBER	DESCRIPTION
	339101	AK MAGNET CIR CLIP (OLD STYLE) to suit 10'' & 12''
	339102	AK MAGNET CLIP (NEW STYLE) to suit 10'' & 12''
	339110	AK MAGNET SPRING to suit 10'' & 12''
	339124	AK BRAKE SHOE ADJUSTER to suit 10'' & 12''
	339126/7	AK SHOE RETAINING SPRING, PIN & CUP to suit 10'' & 12''
	339128	AK 10'' BOTTOM SHOE RETURN SPRING

ELECTRIC BRAKE SPARE PARTS

- to suit 10" ELECTRIC BACKPLATE – AL-KO







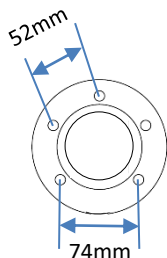





	PART NUMBER	DESCRIPTION
	339130	AK 10" TOP SHOE RETURN SPRING
	339129	AK 10" PARK LEVER SPRING
	339140	AK 12" BOTTOM SHOE RETURN SPRING

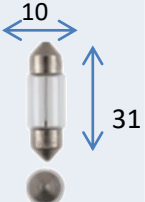













ELECTRIC BRAKE SPARE PARTS













• to suit 12" ELECTRIC BACKPLATE – AL-KO



















	PART NUMBER	DESCRIPTION
	BF12	12" MOUNT PLATE – 60mm HOLE
	339117	AK 12" MAGNET LEVER ARM – R/H
	339116	AK 12" MAGNET LEVER ARM – L/H
	339122/3	PAIR AK 12" ELECTRIC BRAKE SHOES to suit 1 WHEEL
	339300	AK 12" OVAL MAGNET (LOOSE) – L/H or R/H
	339355	AK 12" OVAL OFF-ROAD MAGNET (LOOSE) – R/H
	339350	AK 12" OVAL OFF-ROAD MAGNET (LOOSE) – L/H







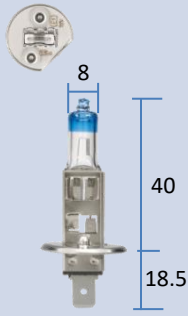
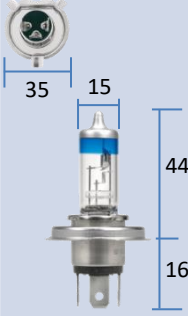
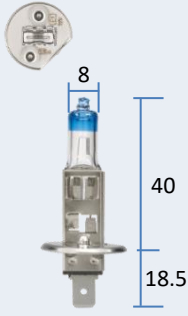
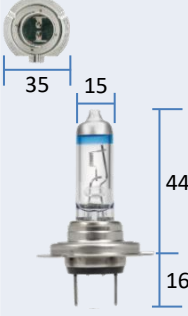
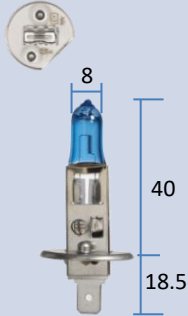

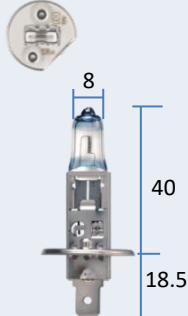
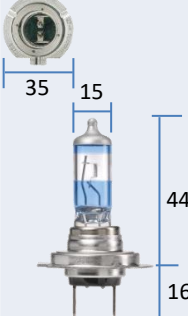

Part No.	Description		Part No.	Description	
47254	FESTOON 12V GLOBE: 12V x 5W		47156	BAYONET 12V GLOBE: 12V x 32CP (SINGLE POLE)	
47258	FESTOON 12V GLOBE: 12V x 5W		47382	BAYONET 12V GLOBE: 12V x 21W (SINGLE POLE)	
47266	FESTOON 12V GLOBE: 12V x 10W		47207	BAYONET 12V GLOBE: 12V x 5W (SINGLE POLE)	
47269	FESTOON 12V GLOBE: 12V x 10W		47209	BAYONET 12V GLOBE: 12V x 5W (DOUBLE POLE)	
47270	FESTOON 12V GLOBE: 12V x 18W (15x41mm)		47233	BAYONET 12V GLOBE: 12V x 4W (SINGLE POLE)	
47003	BAYONET 12V GLOBE: 12V x 15CP (SINGLE POLE)		47281	BAYONET 12V GLOBE: 12V x 2W (SINGLE POLE)	
47005	BAYONET 12V GLOBE: 12V x 21/21W (DOUBLE POLE)		47335	BAYONET 12V GLOBE: 12V x 21W (DOUBLE POLE)	











Part No.	Description		Part No.	Description	
47380	BAYONET 12V GLOBE: 12V x 21/5W (DOUBLE POLE)		47336	BAYONET 24V GLOBE: 24V x 21/5W (DOUBLE POLE)	
47643	BAYONET 12V GLOBE: 12V x 3W (SINGLE POLE)		47286	WEDGE 12V GLOBE: 12V x 1.2W (WEDGE)	
47989	BAYONET 12V GLOBE: 12V x 6W (SINGLE POLE)		47501	WEDGE 12V GLOBE: 12V x 5W (WEDGE)	
47260	FESTOON 24V GLOBE: 24V x 5W		47526	WEDGE 12V GLOBE: 12V x 21CP (WEDGE)	
47653	FESTOON 24V GLOBE: 24V x 5W		56146	3mm MALE BULLETT RED TERMINALS (100/PACK)	
47988	FESTOON 24V GLOBE: 24V x 18W		56150	3mm FEMALE BULLETT RED TERMINALS (100/PACK)	
47333	BAYONET 24V GLOBE: 24V x 32CP (DOUBLE POLE)		56176	4mm BLUE 5/32" RING TERMINALS (100/PACK)	



Part No.	Description		Part No.	Description	
56182	4mm BLUE 5/16" RING TERMINALS (100/PACK)		82072	FLAT 12 PIN BASE	
57810	8 WAY WATERPROOF JUNCTION BOX		82121	7 PIN SMALL ROUND PLUG (PLASTIC)	
57200	H/D 50 AMP CONNECTOR HOUSING & TERMINALS		82141	FLAT 7 PIN PLUG (PLASTIC)	
57215	H/D 175 AMP CONNECTOR HOUSING & TERMINALS		82161	7 PIN LARGE ROUND PLUG (METAL)	
82042	FLAT 7 PIN BASE (PLASTIC)		82162	5 PIN LARGE ROUND PLUG (METAL)	
82052	7 PIN LARGE ROUND BASE (PLASTIC)		82181	7 PIN LARGE ROUND PLUG (PLASTIC)	
82062	7 PIN LARGE ROUND BASE (METAL)		82182	5 PIN LARGE ROUND PLUG (PLASTIC)	

Part No.	Description		Part No.	Description	
82185	7 PIN LARGE ROUND "QUICKFIT" PLUG (PLASTIC)		93602	12V LED 3 IN 1 LIGHT (NO LICENCE PLATE)	 155x76x40
82185/20	7 PIN LARGE ROUND BULK "QUICKFIT" PLUG (PLASTIC)	 (20/PACK)	93604	9-30V LED 3 IN 1 LIGHT (NO LICENCE PLATE)	 155x76x40
82235	7 PIN LARGE ROUND TO 7 PIN FLAT ADAPTOR		93606	12V LED 3 IN 1 LIGHT c/w LICENCE PLATE	 155x76x40
82245	7 PIN FLAT TO 7 PIN LARGE ROUND ADAPTOR		93608	9-30V LED 3 IN 1 LIGHT c/w LICENCE PLATE	 155x76x40
85320A	AMBER LED MAGNETIC BEACON (BATTERY OPERATED)		93630	12V LED 3 IN 1 SLIMLINE LIGHT (NO LICENCE PLATE)	 156x81x26
93402	12V LED 3 IN 1 LIGHT (NO LICENCE PLATE)	 108x108x35	93634	12V LED 3 IN 1 SLIMLINE LIGHT c/w LICENCE PLATE	 156x81x26
93406	12V LED 3 IN 1 LIGHT c/w LICENCE PLATE	 108x108x35	94210	9-33V LED 3 IN 1 LIGHT c/w REVERSE LIGHT	 284x100x37

Part No.	Description	(mm)	Part No.	Description	(mm)
48340BL2	12V 55W H1 PLUS 100 (P14.5s) Performance Globes (2 per BL Pack)		48346BL2	12V 55W H7 PLUS 100 (PX26d) Performance Globes (2 per BL Pack)	
48360BL2	12V 55W H1 PLUS 120 (P14.5s) Performance Globes (2 per BL Pack)		48366BL2	12V 55W H7 PLUS 120 (PX26d) Performance Globes (2 per BL Pack)	
48470BL2	12V 55W H1 INTENSE PLUS 30 (P14.5s) Performance Globes (2 per BL Pack)		48476BL2	12V 55W H7 INTENSE PLUS 30 (PX26d) Performance Globes (2 per BL Pack)	
48530BL2	12V 55W H1 BLUE PLUS 110 (P14.5s) Performance Globes (2 per BL Pack)		48535BL2	12V 55W H7 BLUE PLUS 110 (PX26d) Performance Globes (2 per BL Pack)	

Part No.	Description	TAB or DIA. SIZE		Part No.	Description	TAB or DIA. SIZE	
56020BL	Male Blade Terminal - 2.5 - 3mm, Red (14 per Pack)	6.3 x 0.8 mm or 1/4"		56034BL	Female Blade Terminal - 2.5 - 3mm, RED (18 per Pack)	6.3 x 0.8 mm or 1/4"	
56022BL	Male Blade Terminal - 4mm, Blue (14 per Pack)			56036BL	Female Blade Terminal - 4mm, Blue (14 per Pack)		
56024BL	Male Blade Terminal - 5 - 6mm, Yellow (11 per Pack)			56038BL	Female Blade Terminal - 5 - 6mm, Yellow (12 per Pack)		
56030BL	2-Way M/F Connector - 2.5 - 3mm, Red (10 per Pack)	6.3 x 0.8 mm or 1/4"		56042BL	Female Blade Terminal - 2.5 - 3mm, RED (10 per Pack)	6.3 x 0.8 mm or 1/4"	
56032BL	2-Way M/F Connector - 4mm, Blue (10 per Pack)			56044BL	Female Blade Terminal - 4mm, Blue (10 per Pack)		

Part No.	Description	TAB or DIA. SIZE		Part No.	Description	TAB or DIA. SIZE	
56046BL	Male Bullet Terminal - 2.5 - 3mm, Red (14 per Pack)	4mm or 5/32"		56060BL	Wire Tap Connector - 3 - 4mm, White (6 per Pack)	-	
56048BL	Male Bullet Terminal - 4mm, Blue (14 per Pack)	5mm or 3/16"		56080BL	Ring Terminal - 4mm, Blue (20 per Pack)	6.3 mm or 1/4"	
56050BL	Female Bullet Terminal - 2.5 - 3mm, Red (12 per Pack)	4mm or 5/32"		56082BL	Ring Terminal - 4mm, Blue (14 per Pack)	8.4 mm or 5/16"	
56052BL	Female Bullet Terminal - 4mm, Blue (11 per Pack)	5mm or 3/16"		56088BL	Ring Terminal - 5 - 6mm, Yellow (12 per Pack)	6.3 mm or 1/4"	
56054BL	Cable Joiner - 2.5 - 3mm, RED (15 per Pack)	-		56090BL	Ring Terminal - 5 - 6mm, Yellow (10 per Pack)	8.4 mm or 5/16"	
56056BL	Cable Joiner - 4mm, Blue (14 per Pack)	-		***P.S.: Other Sizes Of Terminals or Connectors Are Available on Request.***			







Part No.	Description		Part No.	Description	
57200BL	H/Duty 50 Amp Connector Housing & Copper Terminals - Gray (BL pack)	 <p>19 mm</p> <p>48L x 36W x 16T (mm)</p>	81026BL	H/Duty Accessory Socket (BL Pack)	 <p>48.5 mm</p> <p>60W x 45H x 44D(mm)</p>
57215BL	H/Duty 175 Amp Connector Housing & Copper Terminals - Gray (BL pack)	 <p>28.5 mm</p> <p>79L x 52W x 25T (mm)</p>	81130BL	H/Duty Merit Socket (BL Pack)	 <p>48.5 mm</p> <p>60W x 45H x 44D(mm)</p>
57810	8 Way Weatherproof Junction Box – suit up to 6mm Cable (1 per Pack)	 <p>47 mm</p> <p>135L x 102W x 38T (mm)</p>	81132BL	H/Duty Engel Type Socket (BL Pack)	 <p>48.5 mm</p> <p>60W x 45H x 44D(mm)</p>
81025BL	H/Duty Surface Mount Accessory Socket (BL Pack)	 <p>53W x 42H x 79D (mm)</p>	81134BL	H/Duty Dual USB Socket (BL Pack)	 <p>48.5 mm</p> <p>60W x 45H x 44D(mm)</p>
81032BL	Cigarette Lighter Plug with Extended Leads & Twin Accessory Sockets - 1mtr (BL Pack)		81140BL	H/Duty Twin Accessory/ Merit Socket (BL Pack)	 <p>26 mm</p> <p>86mm</p> <p>105L x 45H x 44D(mm)</p>

Part No.	Description		Part No.	Description	
81142BL	H/Duty Twin Merit/Engel Type Socket (BL Pack)	 <p>105L x 45H x 44D(mm)</p>	5812-7BK	2.5mm 5 Amps	Black 
81150BL	H/Duty Surface Mount Merit Socket (BL Pack)	 <p>53W x 42H x 79D(mm)</p>	5812-7GN	Single Core Cable - 7mtrs	Green 
81166BL	H/Duty Twin Surface Mount Merit /Engel Type Socket (BL Pack)	 <p>92L x 45H x 83D(mm)</p>	5812-7RD	(Strand NO./dia.: 8/0.32)	Red 
82109BL	Thermoplastic Engel Type Plug (BL Pack)		5822-7SP	2mm 2.5 Amps Speaker Cable - 7mtrs & Grey (Strand NO./dia.: 14/0.20)	
82110BL	Combination Cigarette Lighter Plug/Merit Plug (BL Pack)		5823-4F8	3mm 10 Amps Figure 8 Cable - 4mtrs & Red (Strand NO./dia.: 14/0.20)	

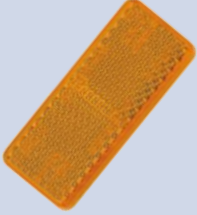

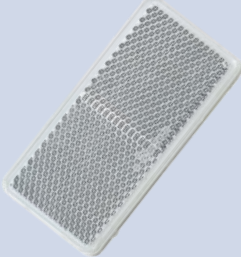

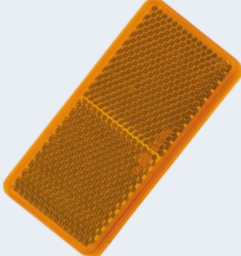
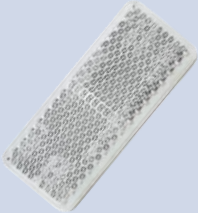

Part No.	Description		Part No.	Description	
5813-7BE	Blue		5814-4BE	Blue	
5813-7BK	Black		5814-4BK	Black	
5813-7BN	Brown		5814-4BN	Brown	
5813-7GN	Green		5814-4GN	Green	
5813-7RD	Red		5814-4RD	Red	
5813-7WE	White		5814-4WE	White	
5813-7YW	Yellow		5814-4YW	Yellow	
	3mm			4mm	
	10 Amps			15 Amps	
	Single Core Cable - 7mtrs			Single Core Cable - 4mtrs	
	(Strand NO./dia.: 14/0.32)			(Strand NO./dia.: 23/0.32)	

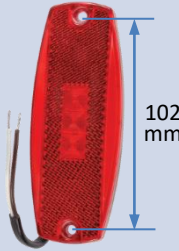

Part No.	Description		Part No.	Description	
82042BL	7 Pin Flat 'Quickfit' Trailer Socket (BL Pack)		82073BL	12 Pin Flat Trailer Socket with Reed Switch (BL Pack)	
82044BL	7 Pin Flat 'Quickfit' Trailer Socket with Reed Switch (BL Pack)		82141BL	7 Pin Flat 'Quickfit' Trailer Plug (BL pack)	
82052BL	7 Pin Large Round Plastic Trailer Socket (BL Pack)		82161BL	7 Pin Large Round Metal Trailer Plug (BL Pack)	
82062BL	7 Pin Large Round Metal Trailer Socket (BL Pack)		82162BL	5 Pin Large Round Metal Trailer Plug (BL Pack)	
82063BL	5 Pin Large Round Metal Trailer Socket (BL Pack)		82171BL	12 Pin Flat Trailer Plug (BL Pack)	
82072BL	12 Pin Flat Trailer Socket (BL Pack)		82181BL	7 Pin Large Round Plastic Trailer Plug (BL Pack)	

Part No.	Description		Part No.	Description	
82185BL	7 Pin Large Round Plastic 'Quickfit' Trailer Plug (BL Pack)		82235BL	7 Pin Large Round Socket on Car to 7 Pin Flat Plug on Trailer (BL Pack)	
82215BL	7 Pin Small Round Socket on Car to 7 Pin Flat Plug on Trailer (BL Pack)		82240BL	5 Pin Large Round Socket on Car to 7 Pin Flat Plug on Trailer (BL Pack)	
82220BL	6 Pin Small Round Socket on Car to 7 Pin Flat Plug on Trailer (BL Pack)		82245BL	7 Pin Flat Socket on Car to 7 Pin Large Round Plug on Trailer (BL Pack)	
82225BL	7 Pin Flat Socket on Car to 7 Pin Small Round Plug on Trailer (BL Pack)		82250BL	7 Pin Flat Socket on Car to 5 Pin Large Round Plug on Trailer (BL Pack)	
82230BL	7 Pin Flat Socket on Car to 6 Pin Small Round Plug on Trailer (BL Pack)		82255BL	7 Pin Large Round Socket on Car to 5 Pin Large Round Plug on Trailer (BL Pack)	

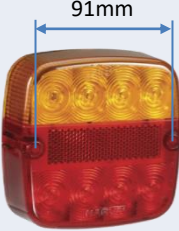
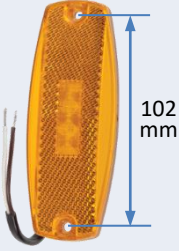

Part No.	Description		Part No.	Description	
82260BL	5 Pin Large Round Socket on Car to 7 Pin Large Round Plug on Trailer (BL Pack)		84036BL	Amber Retro Reflector with Self Adhesive (2 per BL Pack)	 70L x 28H(mm)
82265BL	7 Pin Large Round Socket on Car to 7 Pin Small Round Plug on Trailer (BL Pack)		84037BL	Red Retro Reflector with Self Adhesive (2 per BL Pack)	 70L x 28H(mm)
82270BL	7 Pin Large Round Socket on Car to 6 Pin Small Round Plug on Trailer (BL Pack)		84050BL	Clear Retro Reflector with Self Adhesive (2 per BL Pack)	 94L x 44H(mm)
82280BL	6 Pin Small Round Socket on Car to 7 Pin Large Round Plug on Trailer (BL Pack)		84051BL	Amber Retro Reflector with Self Adhesive (2 per BL Pack)	 94L x 44H(mm)
84035BL	Clear Retro Reflector with Self Adhesive (2 per BL Pack)	 70L x 28H(mm)	84052BL	Red Retro Reflector with Self Adhesive (2 per BL Pack)	 94L x 44H(mm)

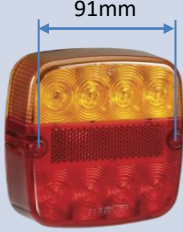
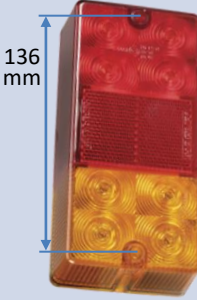
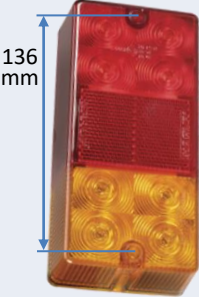

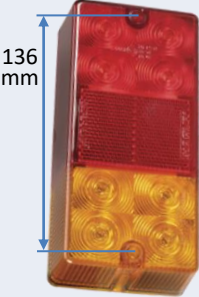
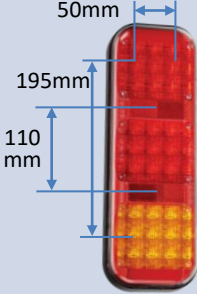
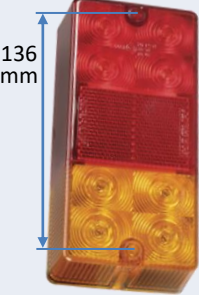
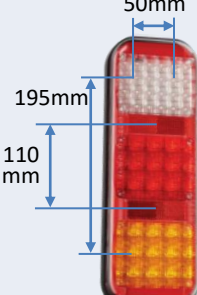
Part No.	Description		Part No.	Description	
85320A	Amber LED Battery Powered Strobe with Magnetic Base (BL Pack)		90862WBL	10-30V LED Licence Plate Lamp in White Housing & 0.5m Cable (BL Pack)	 40mm 97L x 41H (mm)
87508BL	9-33V LED Interior Lamp with Touch Sensitive Switch (BL Pack)	 185L x 150H x 12T (mm)	91402BL	10-33V LED Red/Amber Side Marker Lamp with Black Deflector Base & 0.5m Cable (BL Pack)	 28.5mm 57L x 35H x 21T (mm)
90822CBL	10-30V LED Amber Front End Marker Lamp with Chrome Base & 0.5m Cable (BL Pack)	 72.5mm 110L x 36H x 16T (mm)	91404CBL	10-33V LED Red/Amber Side Marker Lamp with Oval Chrome Base & 0.5m Cable (BL Pack)	 28.5mm 90L x 45H x 26T (mm)
90862BL	10-30V LED Licence Plate Lamp in Charcoal/Black Housing & 0.5m Cable (BL Pack)	 40mm 97L x 41H (mm)	91422BL	10-33V LED Amber Side Marker Lamp with Black Deflector Base & 0.5m Cable (BL Pack)	 28.5mm 57L x 35H x 21T (mm)

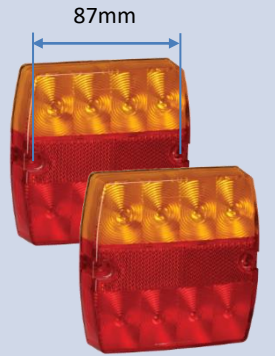
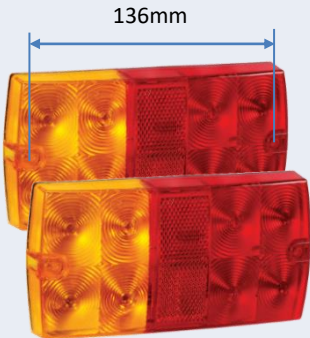
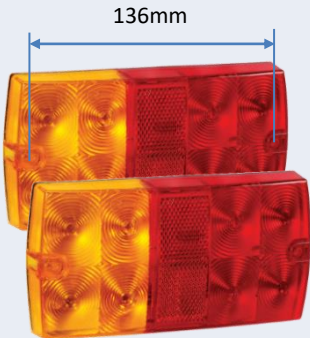



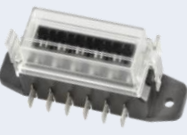

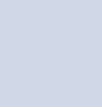
Part No.	Description		Part No.	Description	
91432BL	10-33V LED Red End Marker Lamp with Black Deflector Base & 0.5m Cable (BL Pack)	 57L x 35H x 21T (mm)	91708BL	9-33V LED Red Side Marker Lamp with In-built Retro Reflector Base & 0.5m Cable (BL Pack)	 115L x 44H x 9.5T (mm)
91602BL	9-33V LED Red/Amber Side Marker Lamp with Black Deflector Base & 0.5m Cable (BL Pack)	 74L x 38H x 28T (mm)	93402BL	12V LED Squ. Stop/Tail/Turn Lamp with In-Built Retro Reflector & 0.5m Cable (BL Pack)	 108L x 108H x 35T (mm)
91622BL	9-33V LED Amber Side Clearance Lamp with Black Deflector Base & 0.5m Cable (BL Pack)	 74L x 38H x 28T (mm)	93404BL	9-30V LED Squ. Stop/Tail/Turn Lamp with In-Built Retro Reflector & 0.5m Cable (BL Pack)	 108L x 108H x 35T (mm)
91700BL	9-33V LED Amber Side Marker Lamp with In-built Retro Reflector Base & 0.5m Cable (BL Pack)	 115L x 44H x 9.5T (mm)	93406BL	12V LED Squ. Stop/Tail/Turn & Licence Plate Lamp with In-Built Retro Reflector & 0.5m Cable (BL Pack)	 108L x 108H x 35T (mm)

Part No.	Description		Part No.	Description	
93408BL	9-30V LED Squ. Stop/Tail/Turn & Licence Plate Lamp with In-Built Retro Reflector & 0.5m Cable (BL Pack)	 91mm 108L x 108H x 35T (mm)	93608BL	9-30V LED Rec. Stop/Tail/Turn & Licence Plate Lamp with In-Built Retro Reflector & 0.5m Cable (BL Pack)	 136mm 155L x 76H x 40T (mm)
93602BL	12V LED Rec. Stop/Tail/Turn Lamp with In-Built Retro Reflector & 0.5m Cable (BL Pack)	 136mm 155L x 76H x 40T (mm)	94150HBL	9-33V LED White Reverse Lamp for Horizontal Mounting with 0.5m Cable & Black Case (BL Pack)	 148mm 180L x 100H x 37T (mm)
93604BL	9-30V LED Rec. Stop/Tail/Turn Lamp with In-Built Retro Reflector & 0.5m Cable (BL Pack)	 155L x 76H x 40T (mm)	94202	9-33V LED Twin Stop/Tail/Turn Lamp with In-Built Retro Reflectors & 0.5m Cable (BL Pack)	 50mm 195mm 110mm 284L x 100H x 37T (mm)
93606BL	12V LED Rec. Stop/Tail/Turn & Licence Plate Lamp with In-Built Retro Reflector & 0.5m Cable (BL Pack)	 136mm 155L x 76H x 40T (mm)	94210	9-33V LED Stop/Tail/Turn & Reverse Lamp with In-Built Retro Reflectors & 0.5m Cable (BL Pack)	 50mm 195mm 110mm 284L x 100H x 37T (mm)

Part No.	Description	
93440BL2	<p>12V LED Squ. Slimline Trailer Lamp Pack with Licence Plate Lamp & 0.5m Hard-Wired Tinned Cable per Lamp & Stainless Steel Fittings (Twin BL Pack)</p> <ul style="list-style-type: none"> 1 x 12V LED Squ. Slimline Stop/Tail/Turn Lamp with In-Built Retro Reflector & 0.5m Cable (P/N: 93430) 1 x 12V LED Squ. Slimline Stop/Tail/Turn & Licence Plate Lamp with In-Built Retro Reflector & 0.5m Cable (P/N: 93434) 	 <p>87mm</p> <p>107L x 107H x 26T (mm)</p>
93640BL2	<p>12V LED Rec. Slimline Trailer Lamp Pack with Licence Plate Lamp & 0.5m Hard-Wired Tinned Cable per Lamp & Stainless Steel Fittings (Twin BL Pack)</p> <ul style="list-style-type: none"> 1 x 12V LED Rec. Slimline Stop/Tail/Turn Lamp with In-Built Retro Reflector & 0.5m Cable (P/N: 93630) 1 x 12V LED Rec. Slimline Stop/Tail/Turn & Licence Plate Lamp with In-Built Retro Reflector & 0.5m Cable (P/N: 93634) 	 <p>136mm</p> <p>156L x 81H x 26T (mm)</p>
93642TP	<p>12V LED Rec. Slimline Submersible Trailer Lamp Pack with Licence Plate Lamp & 9m Hard-Wired Tinned Cable per Lamp (Twin BL Pack)</p> <ul style="list-style-type: none"> 1 x 12V LED Rec. Slimline Stop/Tail/Turn Lamp with In-Built Retro Reflector & 9m Cable (P/N: 93631) 1 x 12V LED Rec. Slimline Stop/Tail/Turn & Licence Plate Lamp with In-Built Retro Reflector & 9m Cable (P/N: 93635) 	 <p>136mm</p> <p>156L x 81H x 26T (mm)</p>





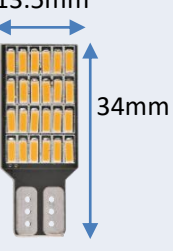
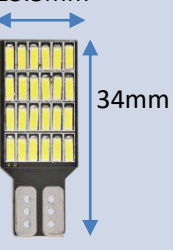

Part No.	Description		Part No.	Description	
54420BL	4-Way STD ATS Blade Fuse Holder (8 Terminals) (BL Pack)	 80L x 45W x 37H (mm)	81135BL	6-33V DC LED Volt Meter (29mm Diameter Mounting Hole) (BL Pack)	
54422BL	6-Way STD ATS Blade Fuse Holder (12 Terminals) (BL Pack)	 100L x 45W x 37H (mm)	81136BL	12-24V DV LED Amp Meter (29mm Diameter Mounting Hole) (BL Pack)	
81051BL	50A H/Duty 5mtrs Battery Connector Extension Lead (BL Pack)		56404	Cable Tie – 4.8 x 200mm (8'') (100 per Pack)	
81067BL	50A H/Duty Adaptor (Battery Clips to Battery Connector) (BL Pack)		56406	Cable Tie – 4.8 x 300mm (8'') (100 per Pack)	
81068BL	50A H/Duty Adaptor (8mm Ring Terminals to Battery Connector) (BL Pack)		56430	Cable Tie Bulk Pack (1000 per Pack) (incl.: 100 - 2.5 x 100mm (4'') 200 - 3.6 x 140mm (5.1/2'') 400 - 4.8 x 200mm (8'') 200 - 4.8 x 300mm (12''))	

Part No.	Description		Part No.	Description	
56707-3	Corrugated Split Sleeve Tubing (Pack) Tube Size: 7mm Internal Dia.: 7mm Length: 3mtrs		5824-5TW	Twin Sheath Cable (BL Pack) Cable Dia.: 4mm AMPS: 15 Length: 5mtrs	
56710-3	Corrugated Split Sleeve Tubing (Pack) Tube Size: 10mm Internal Dia.: 9.7mm Length: 3mtrs		5824-10TW	Twin Sheath Cable (BL Pack) Cable Dia.: 4mm AMPS: 15 Length: 10mtrs	
56711	Corrugated Split Sleeve Tubing (Pack) Tube Size: 10mm Internal Dia.: 9.7mm Length: 30mtrs		5852-6TC	5 Core Trailer Cable (BL Pack) Cable Dia.: 2.5mm AMPS: 5 Length: 6mtrs	
56712	Corrugated Split Sleeve Tubing (Roll) Tube Size: 10mm Internal Dia.: 9.7mm Length: 125mtrs		5852-10TC	5 Core Trailer Cable (BL Pack) Cable Dia.: 2.5mm AMPS: 5 Length: 10mtrs	
56713-3	Corrugated Split Sleeve Tubing (Pack) Tube Size: 13mm Internal Dia.: 12.6mm Length: 3mtrs		<p>***P.S.: Other Sizes Of Tubings or Cables Are Available on Request.***</p>		

Part No.	Description		Part No.	Description	
18020BL	HP 12V LED Festoon Globes – Day White (2 per BL Pack) Globe Type: T-10mm		18060BL	HP 12V LED Wedge Globes – Day White (2 per BL Pack) Globe Base/Type: W2.1 x 9.5d, T-10mm	
18022BL	HP 12V LED Festoon Globes – Cool White (2 per BL Pack) Globe Type: T-10mm		18062BL	HP 12V LED Wedge Globes – Cool White (2 per BL Pack) Globe Base/Type: W2.1 x 9.5d, T-10mm	
18030BL	HP 12V LED Festoon Globes – Cobalt Blue (2 per BL Pack) Globe Type: T-10mm		18070BL	HP 12V LED Wedge Globes – Cobalt Blue (2 per BL Pack) Globe Base/Type: W2.1 x 9.5d, T-10mm	
18040BL	HP 12V LED Festoon Globes – Cool White (2 per BL Pack) Globe Type: SV8-5.8		18080BL	HP 12V LED Wedge Globes – Day White (2 per BL Pack) Globe Base/Type: W2 x 15d, T-15mm	
Warm Red Colour Also Available in Festoon & Wedge Globes on Request.			18082BL	HP 12V LED Wedge Globes – Cool White (2 per BL Pack) Globe Base/Type: W2 x 15d, T-15mm	

Part No.	Description		Part No.	Description	
48382BL2	12V 60/55W H4 P43T Performance Globes – PLUS150 (2 per BL Pack)		71300	'Pocket' Rechargeable LED Inspection Light (BL Pack)	
48386BL2	12V 55W H7 PX26D Performance Globes – PLUS150 (2 per BL Pack)		71301	'HP Pocket' Rechargeable LED Inspection Lamp (Boxed)	
71740	ULTIMA 215 LED 9-33V Driving Light (1 per Box)	 215W x 112D x 235H (mm)	71345	HP Rechargeable Mini LED Floodlight (Boxed)	 185W x 165H x 55D (mm)
74403	Driving Light Harness to suit ULTIMA 215 LED (BL Pack)		72358	9-36V 5 x 3W HP LED Work Lamp – 1050 Lumens & Polycarbonate Lens (BL Pack)	 142L x 45H x 93D (mm)
			72360	9-36V 4 x 5W HP LED Work Lamp – 2000 Lumens & Polycarbonate Lens (BL Pack)	 75L x 79H x 79D (mm)

Part No.	Description	
85010A	<p>12/24 Volt Aeromax Mini LED Light Box (Amber) Flange Base & Amber Lens (Boxed)</p> <ul style="list-style-type: none"> • 8 Selectable Flash Patterns • Polycarbonate Lens • Class 1 Approved 	 <p>200L x 173W x 47H (mm)</p>
85012A	<p>12/24 Volt Aeromax Mini LED Light Box (Amber) Magnetic Base (Boxed)</p> <ul style="list-style-type: none"> • 8 Selectable Flash Patterns • Polycarbonate Lens • Class 1 Approved 	 <p>200L x 173W x 47H (mm)</p>
85254A	<p>12/24 Volt 'Eurotech' Low Profile LED Strobe/Rotator Light (Amber) Flange Base (Boxed)</p> <ul style="list-style-type: none"> • 6 Selectable Flash Patterns • Polycarbonate Lens • Class 1 Approved 	 <p>142φ x 80H (mm)</p>
85260A	<p>12/24 Volt 'Eurotech' LED Strobe/Rotator Light (Amber) Flange Base (Boxed)</p> <ul style="list-style-type: none"> • 6 Selectable Flash Patterns • Polycarbonate Lens • Class 1 Approved 	 <p>142φ x 129H (mm)</p>
85274A	<p>12/24 Volt Hi Optics LED Rotating Beacon (Amber) Magnetic Base (Boxed)</p> <ul style="list-style-type: none"> • Polycarbonate Lens • Class 1 Approved • Cigarette Lighter/Merit Plug 	 <p>200φ x 121φ x 175H (mm)</p>
85658A	<p>12/24 Volt Optimax Rotating Beacon (Amber) Magnetic Base (Boxed)</p> <ul style="list-style-type: none"> • Polycarbonate Lens • Cigarette Lighter/Merit Plug • 12V Globe (P/N: 48320) & 24V Globe (P/N: 48702) Are Included In The Box 	 <p>153φ x 110φ x 180H (mm)</p>

Part No.	Description	
MX580BL	10-30 Volt LED Side Marker Lamp (Red/Amber) with Black Deflector Base & 400mm Hard Wired Cable (1 per BL Pack) <ul style="list-style-type: none"> Acrylic Lenses 	 <p>58L x 35H x 25D (mm)</p>
MX581BL	10-30 Volt LED Front End Outline Marker Lamp (White) with Black Deflector Base & 400mm Hard Wired Cable (1 per BL Pack) <ul style="list-style-type: none"> Acrylic Lenses 	 <p>58L x 35H x 25D (mm)</p>
MX582BL	10-30 Volt LED Side Direction Indicator, Side Marker and Front End Outline Marker Lamp (Amber) with Black Deflector Base & 400mm Hard Wired Cable (1 per BL Pack) <ul style="list-style-type: none"> Acrylic Lenses 	 <p>58L x 35H x 25D (mm)</p>
MX700BL2	10-30 Volt LED Licence Plate Lamp in Black Housing & 150mm Cable (2 per BL Pack) <ul style="list-style-type: none"> Acrylic Lenses 	 <p>70L x 26H x 25D (mm)</p>
MX102BL2	12 Volt LED Square Rear Combination Trailer Lamp Kit (Pair per BL Pack) <ul style="list-style-type: none"> 1 x Squ. Rear Stop/Tail, Direction Indicator Lamp with In-built Retro Reflector & 400mm of Cable 1 x Squ. Rear Stop/Tail, Direction Indicator with Licence Plate Lamp, In-built Retro Reflector & 400mm of Cable Acrylic Lenses 	 <p>100L x 100H x 26T (mm)</p>
MX152BL2	12 Volt LED Rectangle Rear Combination Trailer Lamp Kit (Pair per BL Pack) <ul style="list-style-type: none"> 1 x Rec. Rear Stop/Tail, Direction Indicator Lamp with In-built Retro Reflector & 400mm of Cable 1 x Rec. Rear Stop/Tail, Direction Indicator with Licence Plate Lamp, In-built Retro Reflector & 400mm of Cable Acrylic Lenses 	 <p>150L x 80H x 26T (mm)</p>

Part No.	Description	
MX160	<p>10-30 Volt LED Rear Combination Lamp (Boxed)</p> <ul style="list-style-type: none">• 1 x Rec. Rear Stop/Tail/Direction Indicator, Reverse Lamp with In-built Retro Reflector & 400mm of Cable• Acrylic Lenses	 <p>283L x 100H x 30D (mm)</p>



Part No.	Description	
AC250B	<p>12V 2 Stage Automatic Battery Charger</p> <ul style="list-style-type: none"> • Charge & Maintain • Input: 240V, 50Hz, 28W • Output: 1600mA at 12.0V • Unit Size: 123W x 118H x 43T (mm) 	 <p>APPLICATION GUIDE</p> <p> AUTOMOTIVE BATTERIES (CHARGE)</p> <p> AUTOMOTIVE BATTERIES (MAINTAIN)</p>
PC400	<p>12V 6 Stage Automatic Battery Charger</p> <ul style="list-style-type: none"> • Pro-Charge Range • Input: 240VAC, 50Hz, 132W • Output: 12V • Output Current: 1, 2, 4A • Unit Size: 167W x 104H x 66T (mm) 	 <p>APPLICATION GUIDE</p> <p> AUTOMOTIVE BATTERIES (Inc. CALCIUM)</p> <p> MARINE BATTERIES</p> <p> DEEP CYCLE BATTERIES</p>
PC800	<p>12V 6 Stage Automatic Battery Charger</p> <ul style="list-style-type: none"> • Pro-Charge Range • Input: 240VAC, 50Hz, 240W • Output: 12V • Output Current: 2, 4, 8A • Unit Size: 216W x 118H x 66T (mm) 	 <p>APPLICATION GUIDE</p> <p> AUTOMOTIVE BATTERIES (Inc. CALCIUM)</p> <p> MARINE BATTERIES</p> <p> DEEP CYCLE BATTERIES</p>
PW600	<p>Pro-Wave Pure Sine Wave Inverter</p> <ul style="list-style-type: none"> • Input: 12V DC, 60A Max • Output: 240VAC, 50Hz • Output Power: 600W Continuous (1200W Peak) • Unit Size: 339W x 190H x 81T (mm) 	 <p>APPLICATION GUIDE</p> <p></p>
IDC25	<p>Deep Cycle 9-32V 3 Stage Dual Battery Charger</p> <ul style="list-style-type: none"> • Intelli-Charge DC/Solar • Max. Solar Input: 23Vdc, 385W • Output Current: Input 9-11Vdc 20A, Input 11-32Vdc 25A • Battery Capacity: 75-300Ah • Unit Size: 150L x 122H x 40T (mm) 	
BPE330	<p>12V Portable Power Station – 3 Power Outlets</p> <ul style="list-style-type: none"> • Battery Box Only suit N70 Size Batteries • Material: Polypropylene • Internal Size: 330L x 190W x 200H (mm) • External Size: 390L x 220W x 280H (mm) 	
IS1500	<p>Intelli-Start 12V Professional Lithium Jumpstarter</p> <ul style="list-style-type: none"> • Battery Capacity: 8Ah, 32,000mAh, 102.4wHr • Theoretical Short Circuit Current: 1500A • Clamp Output: 550A • Jumpstarter Leads: 55cmL x 20mm² • Weight & Dimensions: 4kg, 235L x 180W x 196H (mm) 	 <p>APPLICATION GUIDE</p> <p> AUTOMOTIVE BATTERIES</p> <p> MARINE BATTERIES</p>

Part No.	Description		Part No.	Description	
CRL14LHX	12V L/H LED 3 IN 1 LIGHT (NO LICENCE PLATE)	 100x100x30	CRL280	9-33V LED 3 IN 1 LIGHT (NO LICENCE PLATE)	 284x100x37
CRL14RHX	12V R/H LED 3 IN 1 LIGHT c/w LICENCE PLATE		CRL405	9-33V LED 3 IN 1 LIGHT (NO LICENCE PLATE)	 401x131x42
CRL14VLHB	10-30V L/H LED 3 IN 1 LIGHT (NO LICENCE PLATE)		CRL605	9-33V LED 3 IN 1 LIGHT (NO LICENCE PLATE)	 601x131x42
CRL14VRHB	10-30V R/H LED 3 IN 1 LIGHT c/w LICENCE PLATE		CRL220	9-33V LED 3 IN 1 LIGHT (NO LICENCE PLATE)	 222x96x34
CRL108TWB	12V LED 3 IN 1 LIGHT (NO LICENCE PLATE)		 148x76x22	RM62R	9-33V LED RED REAR MARKER LIGHT
CRL106V	10-33V LED 3 IN 1 LIGHT (NO LICENCE PLATE)	 150x80x30	SM62RA	9-33V LED RED/AMBER SIDE MARKER LIGHT	 57x35x21
CRL280R	9-33V LED 3 IN 1 LIGHT c/w REVERSE LIGHT (NO LICENCE PLATE)	 284x100x37	SM13RA	9-33V LED RED/AMBER SIDE MARKER LIGHT	 120x64x32

Part No.	Description		Part No.	Description	
SM62A	9-33V LED AMBER SIDE MARKER LIGHT	 57x35x21	TR12A	AMBER REFLECTOR (Stick On)	
FM62C	9-33V LED CLEAR FRONT MARKER LIGHT	 57x35x21	TR12C	CLEAR REFLECTOR (Stick On)	 70x20x7.5
RR60A	AMBER REFLECTOR (Bolt On)		TR12R	RED REFLECTOR (Stick On)	
RR60C	CLEAR REFLECTOR (Bolt On)	 60x8	TRB185	6 Ft. TRAILER LIGHT BOARD	 915x139
RR60R	RED REFLECTOR (Bolt On)		TB1500	5 Ft. (LED) TRAILER LIGHT BOARD	 915x139
TR106A	AMBER REFLECTOR (Stick On)		NPL2	9-33V LED LICENCE PLATE LIGHT	 105x48x37.5
TR106C	CLEAR REFLECTOR (Stick On)	 59x31x7.5	NPL7B	9-33V LED LICENCE PLATE LIGHT	 92x50x50
TR106R	RED REFLECTOR (Stick On)				

Part No.	Description
ASC11603B30	30mtr x 3mm SINGLE CORE WIRE BLACK
ASC11603L30	30mtr x 3mm SINGLE CORE WIRE BLUE
ASC11603N30	30mtr x 3mm SINGLE CORE WIRE BROWN
ASC11603R30	30mtr x 3mm SINGLE CORE WIRE RED
ASC11603W30	30mtr x 3mm SINGLE CORE WIRE WHITE
ASC11603Y30	30mtr x 3mm SINGLE CORE WIRE YELLOW
ASC11603B100	500mtr x 3mm SINGLE CORE WIRE BLACK
ASC11603G100	500mtr x 3mm SINGLE CORE WIRE GREEN
ASC11603L100	500mtr x 3mm SINGLE CORE WIRE BLUE
ASC11603N100	500mtr x 3mm SINGLE CORE WIRE BROWN
ASC11603R100	500mtr x 3mm SINGLE CORE WIRE RED
ASC11603W100	500mtr x 3mm SINGLE CORE WIRE WHITE
ASC11603Y100	500mtr x 3mm SINGLE CORE WIRE YELLOW
ASC12603L100	100mtr x 4mm SINGLE CORE WIRE BLUE
ASC16503B30	30mtr x 6mm SINGLE CORE WIRE BLACK



Part No.	Description
AWC21603	1mtr x 3mm TWIN SHEATH WIRE
AWC21603B30	30mtr x 3mm TWIN SHEATH WIRE
AWC21603B100	100mtr x 3mm TWIN SHEATH WIRE
AWC21603B500	500mtr x 3mm TWIN SHEATH WIRE
AWC22603	1mtr x 4mm TWIN SHEATH WIRE
AWC22603B30	30mtr x 4mm TWIN SHEATH WIRE
AWC22603B100	100mtr x 4mm TWIN SHEATH WIRE
AWC22603B500	500mtr x 4mm TWIN SHEATH WIRE
AWC24103B30	30mtr x 5mm TWIN SHEATH WIRE
AWC24103B100	100mtr x 5mm TWIN SHEATH WIRE
AWC26503B30	30mtr x 6mm TWIN SHEATH WIRE
AWC26503B100	100mtr x 6mm TWIN SHEATH WIRE

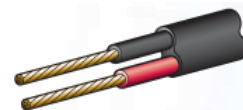

3mm

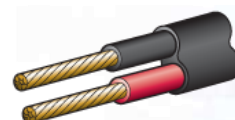

4mm

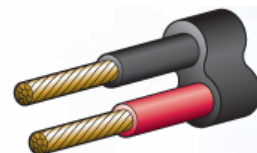

5mm

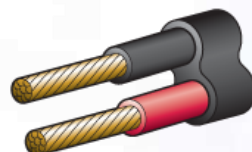

6mm

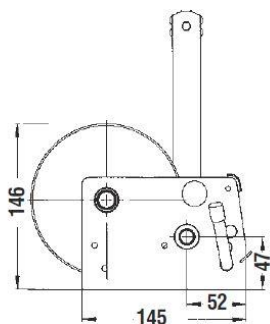

Side Elevation

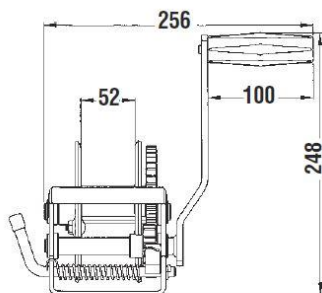

Front Elevation

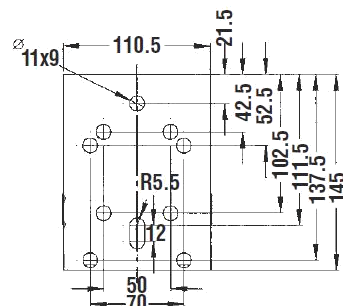

Boltdown Specs.

F10212
3:1 L/DUTY WINCH (SMALL)
c/w CABLE



TYPE OF RATCHET	APPLICATION	RATED CAPACITY	CABLE BREAKING STRAIN	CABLE (AS SUPPLIED)	MAX. EFFORT ON HANDLE @ RATED LOAD
LEVER ACTION	PULLING	500KG (4900N)	865KG	6m X 4mm	20KG

F10202
3:1 L/DUTY WINCH (SMALL)
c/w WEBBING



TYPE OF RATCHET	APPLICATION	RATED CAPACITY	MASS (NO WEBBING)	WEBBING (AS SUPPLIED)	MAX. EFFORT ON HANDLE @ RATED LOAD
LEVER ACTION	PULLING	500KG (4900N)	3.81KG	6m	20KG

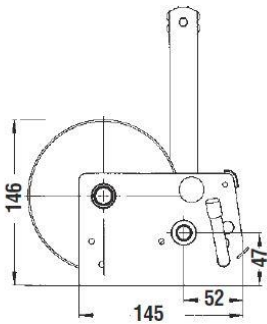

Side Elevation

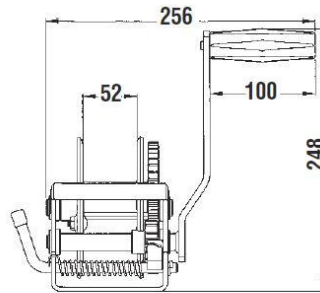

Front Elevation

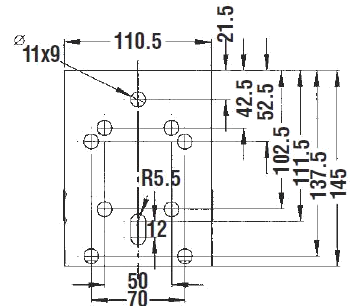

Boltdown Specs.

F10214

5:1 MED/DUTY WINCH

c/w CABLE



TYPE OF RATCHET	APPLICATION	RATED CAPACITY	CABLE BREAKING STRAIN	CABLE (AS SUPPLIED)	MAX. EFFORT ON HANDLE @ RATED LOAD
LEVER ACTION	PULLING	700KG (6860N)	865KG	6m X 4mm	25KG

F10204

5:1 MED/DUTY WINCH

c/w WEBBING



TYPE OF RATCHET	APPLICATION	RATED CAPACITY	MASS (NO WEBBING)	WEBBING (AS SUPPLIED)	MAX. EFFORT ON HANDLE @ RATED LOAD
LEVER ACTION	PULLING	700KG (6860N)	4.07KG	6m	25KG

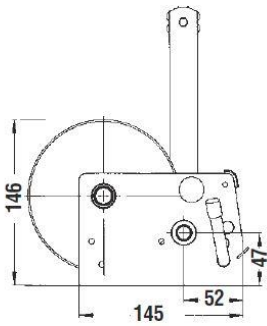

Side Elevation

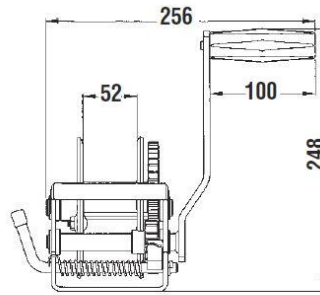

Front Elevation

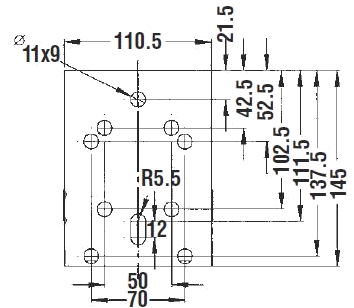

Boltdown Specs.

F10217
5:1 1:1 H/DUTY WINCH
c/w CABLE

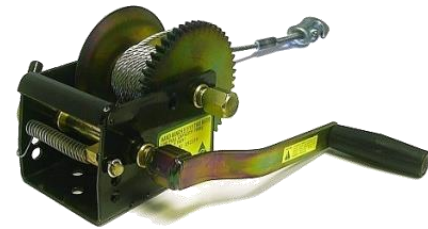

TYPE OF RATCHET	APPLICATION	RATED CAPACITY	CABLE BREAKING STRAIN	CABLE (AS SUPPLIED)	MAX. EFFORT ON HANDLE @ RATED LOAD
LEVER ACTION	PULLING	700KG (6860N)	1855KG	6m X 5mm	25KG

F10206
5:1 1:1 H/DUTY WINCH
c/w WEBBING



TYPE OF RATCHET	APPLICATION	RATED CAPACITY	MASS (NO WEBBING)	WEBBING (AS SUPPLIED)	MAX. EFFORT ON HANDLE @ RATED LOAD
LEVER ACTION	PULLING	700KG (6860N)	4.07KG	6m	25KG

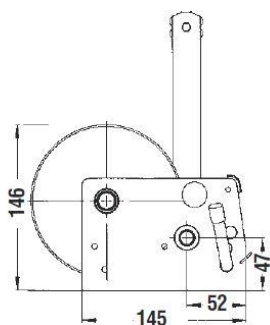

Side Elevation

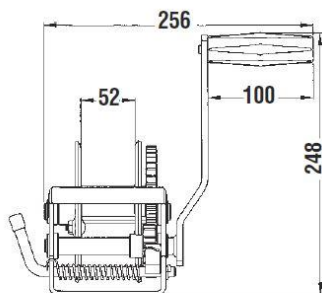

Front Elevation

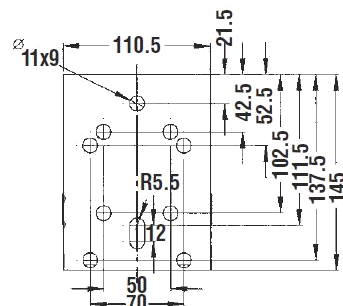

Boltdown Specs.

F10950 10:1 5:1 1:1 EX. H/DUTY WINCH c/w CABLE

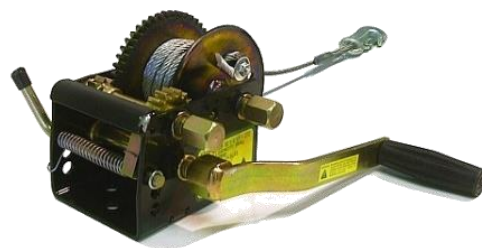

TYPE OF RATCHET	APPLICATION	RATED CAPACITY	CABLE BREAKING STRAIN	CABLE (AS SUPPLIED)	MAX. EFFORT ON HANDLE @ RATED LOAD
LEVER ACTION	PULLING	800KG – 1000KG	1855KG	7.5m X 5mm	18KG

F10952 10:1 5:1 1:1 EX. H/DUTY WINCH c/w WEBBING



TYPE OF RATCHET	APPLICATION	RATED CAPACITY	MASS (NO WEBBING)	WEBBING (AS SUPPLIED)	MAX. EFFORT ON HANDLE @ RATED LOAD
LEVER ACTION	PULLING	800KG – 1000KG	4.99KG	7.5m	18KG

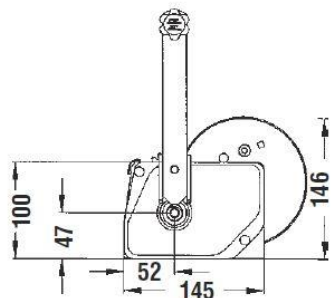

Side Elevation

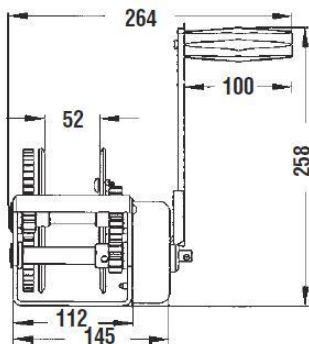

Front Elevation

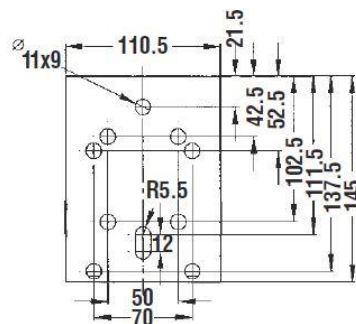

Boltdown Specs.

F18230

5:1 (300KG) BRAKE WINCH c/w CABLE

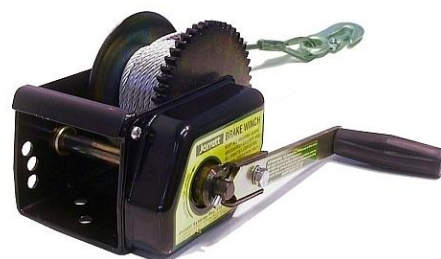

TYPE OF BRAKE	APPLICATION	RATED CAPACITY	CABLE BREAKING STRAIN	CABLE (AS SUPPLIED)	MAX. EFFORT ON HANDLE @ RATED LOAD
SELF ACTUATING	LIFTING	300KG (2940N)	1905KG	7.5m X 5mm	26KG

F18260

10:1 (500KG) BRAKE WINCH c/w CABLE



TYPE OF BRAKE	APPLICATION	RATED CAPACITY	CABLE BREAKING STRAIN	CABLE (AS SUPPLIED)	MAX. EFFORT ON HANDLE @ RATED LOAD
SELF ACTUATING	LIFTING	500KG (4900N)	2800KG	7.5m X 6mm	18KG



Part No.

Description

51D

4mm x 6mtr. Cable c/w Snap Hook

51E

5mm x 6mtr. Cable c/w Snap Hook

10111G

6mm x 5.5mtr. Cable c/w Snap Hook



Part No.

Description

51F

6mtr. Webbing c/w Snap Hook

10111H

7.5mtr. Webbing c/w Snap Hook

AL-KO Premium Marine Winches come in 5 capacities – 250kg, 500kg, 700kg, 1000kg and 1200kg, and are available with cable or webbing. Perfectly suited for quick boat retrieval onto a multi-roller trailer all 500 kg and above AL-KO Premium Marine Winches are multi speed with 2 or 3 speeds. The 1:1 ratio enables the initial retrieval of the boat onto the rollers and the second (or third) ratios allow for the full weight of your boat to be pulled onto the trailer, with ease. These winches are of the highest quality to ensure long trouble free operation. They feature ultra high strength shaft bushes, a stainless steel drive shaft, drive pawl and spring system for maximum corrosion resistance. A unique feature of the Premium range is the galvanised rectangular frame that provides the high resistance to torsional distortion. The clever handle design allows quick release and re-attachment to the desired gear shaft without the operator having to jump from one side of the trailer to the other. The bolt hole patterns suit most existing boat trailers.

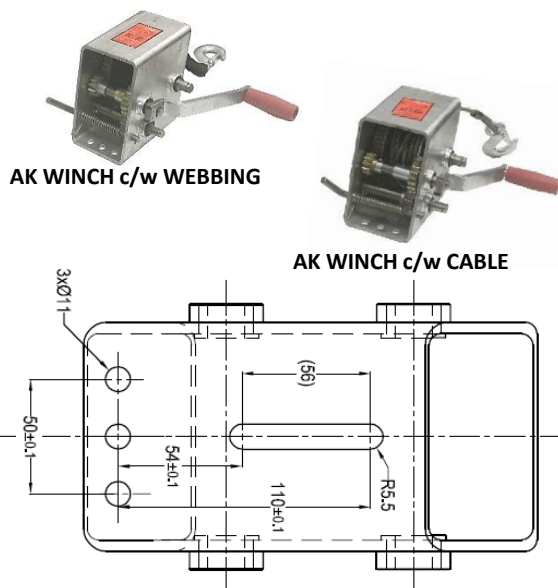

Base/ Mounting Details

PART NO.	CABLE / WEBBING	RATED LINE FULL CAPACITY	GEAR RATIO	HOOK	CABLE LENGTH	WEBBING LENGTH	HANDLE LENGTH	WEIGHT
635001W	WEBBING	250KG	1:1	"S"	--	50MM X 4M	190MM	3.4KG
635003	CABLE	500KG	3:1 1:1	"S"	4MM X 6M	--	190MM	4.1KG
635003W	WEBBING	500KG	3:1 1:1	"S"	--	50MM X 4M	190MM	3.9KG
635005	CABLE	700KG	5:1 1:1	SNAP	5MM X 6M	--	190MM	6.9KG
635005W	WEBBING	700KG	5:1 1:1	SNAP	--	50MM X 6M	190MM	6.8KG
635010	CABLE	1000KG	10:1 5:1 1:1	SNAP	6MM X 7.5M	--	190MM	8.6KG
635010W	WEBBING	1000KG	10:1 5:1 1:1	SNAP	--	50MM X 7.5M	190MM	8.1KG
635015	CABLE	1200KG	15:1 5:1 1:1	SNAP	6MM X 7.5M	--	190MM	8.7KG
635015W	WEBBING	1200KG	15:1 5:1 1:1	SNAP	--	50MM X 7.5M	190MM	8.2KG

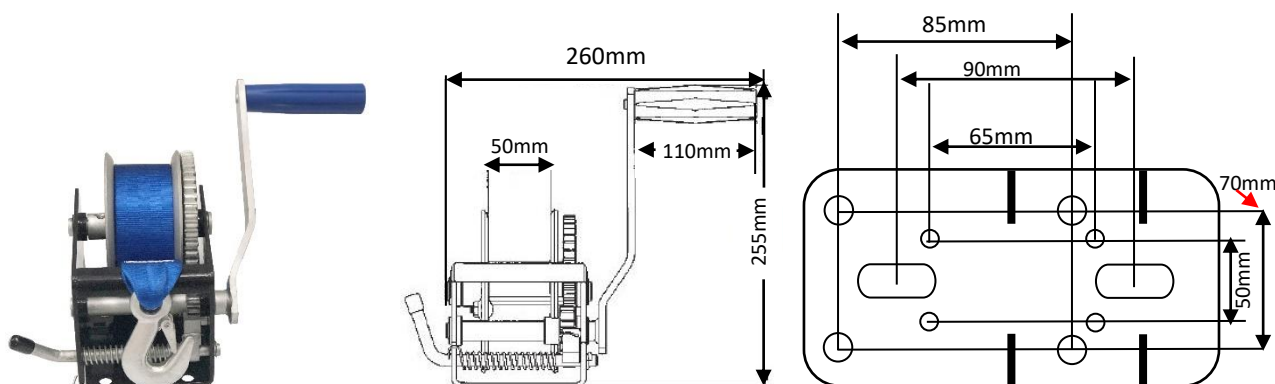

3:1 BLACK POWDER COATED WINCH c/w 7mtr BLUE WEBBING

PART NO.	RATED CAPACITY	WEBBING SIZE	WEIGHT
SAHW31W	500KG	50mm x 7mtr	5.1KG



3:1 BLACK POWDER COATED WINCH c/w 6mtr BLUE ROPE

PART NO.	RATED CAPACITY	WEBBING SIZE	WEIGHT
SAHW31R	500KG	4mm x 6mtr	5.1KG

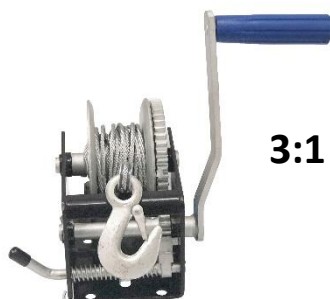

3:1 BLACK POWDER COATED WINCH c/w 6mtr CABLE

PART NO.	RATED CAPACITY	WEBBING SIZE	WEIGHT
SAHW31C	500KG	4mm x 6mtr	5.1KG

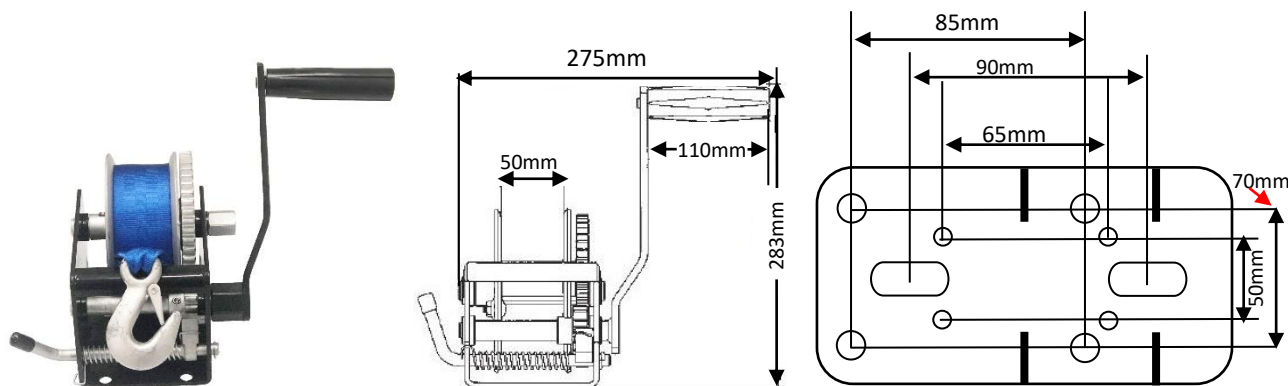

5:1 1:1 BLACK POWDER COATED WINCH c/w 7mtr BLUE WEBBING

PART NO.	RATED CAPACITY	WEBBING SIZE	WEIGHT
SAHW51W	700KG	50mm x 7mtr	5.2KG

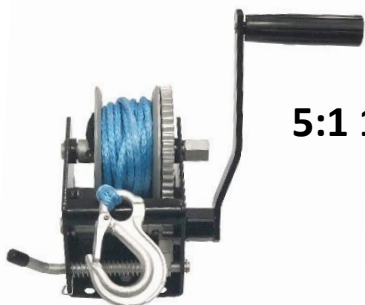

5:1 1:1 BLACK POWDER COATED WINCH c/w 7.5mtr BLUE ROPE

PART NO.	RATED CAPACITY	WEBBING SIZE	WEIGHT
SAHW51R	700KG	5mm x 7.5mtr	5.2KG

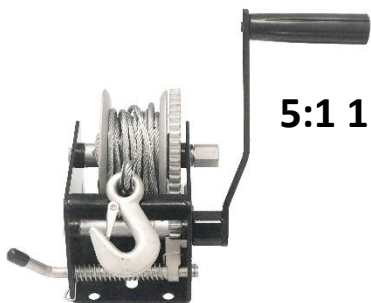

5:1 1:1 BLACK POWDER COATED WINCH c/w 7.5mtr CABLE

PART NO.	RATED CAPACITY	WEBBING SIZE	WEIGHT
SAHW51C	700KG	5mm x 7.5mtr	5.2KG

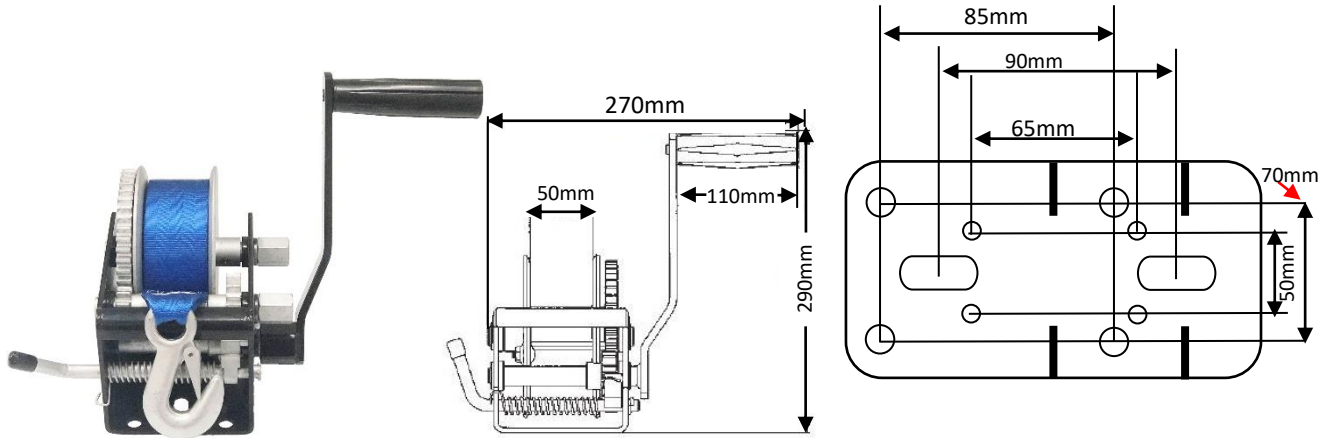

**10:1 5:1 1:1 BLACK POWDER COATED
WINCH c/w 8mtr BLUE WEBBING**

PART NO.	RATED CAPACITY	WEBBING SIZE	WEIGHT
SAHW101W	1000KG	50mm x 8mtr	5.7KG

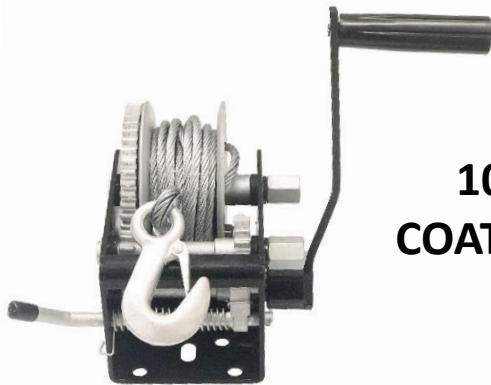

**10:1 5:1 1:1 BLACK POWDER
COATED WINCH c/w 7.5mtr CABLE**

PART NO.	RATED CAPACITY	WEBBING SIZE	WEIGHT
SAHW101C	1000KG	5mm x 7.5mtr	5.7KG

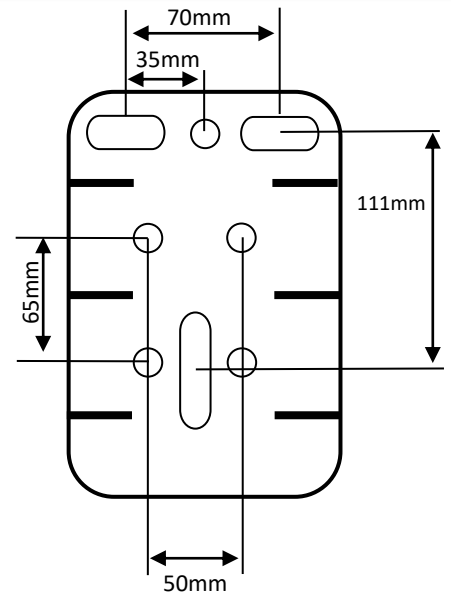
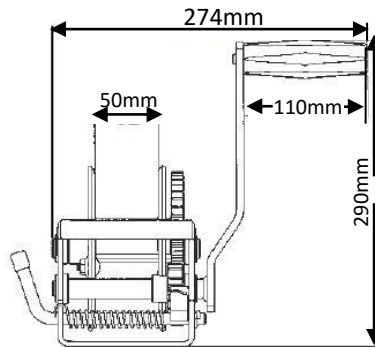
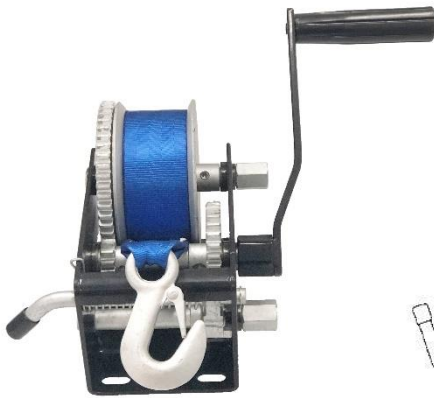

**15:1 4.5:1 1:1 BLACK POWDER COATED
WINCH c/w 8mtr BLUE WEBBING**

PART NO.	RATED CAPACITY	WEBBING LENGHT	WEIGHT
SAHW151W	1500KG	50mm x 8mtr	6.7KG

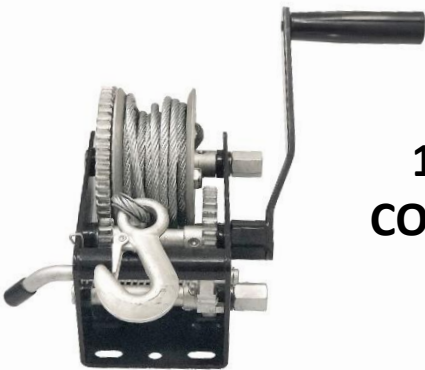

**15:1 4.5:1 1:1 BLACK POWDER
COATED WINCH c/w 7.5mtr CABLE**

PART NO.	RATED CAPACITY	WEBBING LENGHT	WEIGHT
SAHW151C	1500KG	5mm x 7.5mtr	6.7KG

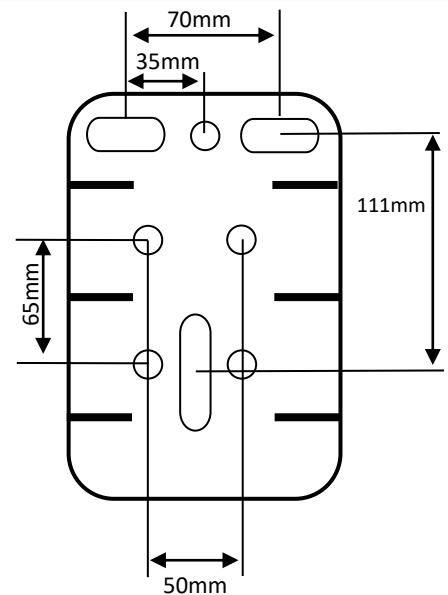
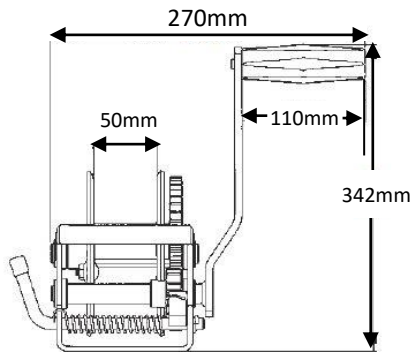
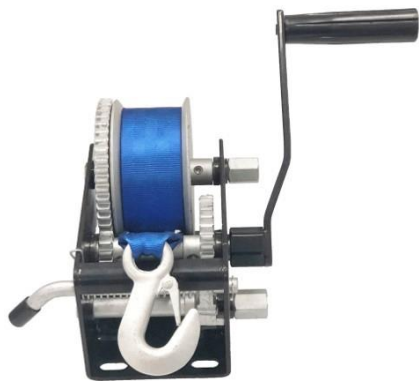



**17:1 5:1 1:1 BLACK POWDER COATED
WINCH c/w 10mtr BLUE WEBBING**

PART NO.	RATED CAPACITY	WEBBING LENGHT	WEIGHT
SAHW171W	2000KG	50mm x 10mtr	6.7KG



















**17:1 5:1 1:1 BLACK POWDER
COATED WINCH c/w 10mtr CABLE**

PART NO.	RATED CAPACITY	WEBBING LENGHT	WEIGHT
SAHW171C	2000KG	5mm x 10mtr	6.7KG

	PART NO.	DESCRIPTION
	635905	WINCH HANDLE (STD.) 190mm
	632541	AK 11 TOOTH WINCH COG
	632542	AK 22 TOOTH WINCH COG
	632543	AK 33 TOOTH WINCH COG
	632531	AK 16mm WINCH BUSH
	632532	AK 20mm WINCH BUSH

	PART NO.	DESCRIPTION
	SA507W	SPARE BLUE WEBBING (50mm x 7mtr)
	SA508W	SPARE BLUE WEBBING (50mm x 8mtr)
	SA46C	SPARE CABLE (4mm x 6mtr)
	SA57C	SPARE CABLE (5mm x 7.5mtr)
	SA67C	SPARE CABLE (6mm x 7.5mtr)
	SA46R	SPARE BLUE ROPE (4mm x 6mtr)
	SA57R	SPARE BLUE ROPE (5mm x 7.5mtr)
	SAWHB	SPARE POWDER COATED HANDLE (230mm) (BL PACK)
	SAWHD	SPARE POWDER COATED HANDLE (230mm) (BL PACK)

	PART NO.	DESCRIPTION
	R034-150-16	6" PARALLEL POLY ROLLER (16mm BORE) (6" LONG x 3" OUTER DIAMETER)
	R034-150-19	6" PARALLEL POLY ROLLER (19mm BORE) (6" LONG x 3" OUTER DIAMETER)
	R034-300-19	12" PARALLEL POLY ROLLER (19mm BORE) (12" LONG x 3" OUTER DIAMETER)
	R034-300-25	12" PARALLEL POLY ROLLER (25mm BORE) (12" LONG x 3" OUTER DIAMETER)
	0006P	3" COTTON REEL POLY ROLLER (16mm BORE) (3" LONG x 2.3/4" CHAMFER TO 2")
	0100P	4" COTTON REEL POLY ROLLER (16mm BORE) (4" LONG x 2.3/4" CHAMFER TO 2")
	0300P	6" COTTON REEL POLY ROLLER (16mm BORE) (6.1/4" LONG x 2.7/8" CHAMFER TO 2")
	0103P-16	8" COTTON REEL POLY ROLLER (16mm BORE) (7.1/2" LONG x 2.7/8" CHAMFER TO 2")

	PART NO.	DESCRIPTION
	0103P-19	8" COTTON REEL POLY ROLLER (19mm BORE) (7.1/2" LONG x 2.7/8" CHAMFER TO 2")
	0110P	12" COTTON REEL POLY ROLLER (25mm BORE) (11.3/4" LONG x 3.1/4" CHAMFER TO 2")
	R013-170	6" SELF CENTERING POLY ROLLER (16mm BORE) (6.1/2" LONG x 2.1/4" OUTER DIAMETER)
	R013-195	8" SELF CENTERING POLY ROLLER (19mm BORE) (7.3/4" LONG x 2.1/2" OUTER DIAMETER)
	R040	3" POLY GUIDE BALL ROLLER (19mm BORE) (3" x 3")
	R095	POLY WOBBLE ROLLER ONLY (25mm BORE) (4.1/4" LONG x 3.1/2" OUTER DIAMETER)
	V010S	SMALL POLY "V" BLOCK (12mm BORE) (3.1/2" LONG x 3.1/2" DEEP x 2" WIDE)
	V010L	LARGE POLY "V" BLOCK (19mm BORE) (4.1/2" LONG x 4.1/2" DEEP x 3.1/4" WIDE)

PART NO.	DESCRIPTION	PART NO.	DESCRIPTION
761061/071	4.1/2" ROLLER BRACKET & 16mm PIN	761071	4.1/2" x 16mm ROLLER PIN ONLY (OVERALL LENGTH 5.3/4")
761062/072	6" ROLLER BRACKET & 16mm PIN	761072	6" x 16mm ROLLER PIN ONLY (OVERALL LENGTH 8")
761063/079	8" ROLLER BRACKET & 16mm PIN	761079	8" x 16mm ROLLER PIN ONLY (OVERALL LENGTH 9.1/2")
761065/073	8" ROLLER BRACKET & 19mm PIN	761073	8" x 19mm ROLLER PIN ONLY (OVERALL LENGTH 9.1/2")
761064/074	12" ROLLER BRACKET & 25mm PIN	761074	12" x 25mm ROLLER PIN ONLY (OVERALL LENGTH 14.1/4")



4.1/2" BRACKET



6" BRACKET



8" BRACKET



12" BRACKET



4.1/2" x 16mm PIN



6" x 16mm PIN



8" x 16mm PIN



8" x 19mm PIN



12" x 25mm PIN

Part No.	Description
B170	Std. Bearing Buddy
2562	2.1/2" Bearing Buddy to Suit 2 Ton Hub
2562-C	2.1/2" Bearing Buddy Cover
630010	ALKO Bearing Buddy – Loose
630015	ALKO Red Bearing Buddy Cover
761197	Black Bearing Buddy Cover



Part No.	Description	Weight
581201-65	Liplex EP2 Water proof Grease High Temperature, Multipurpose Automotive and Industrial grease Recommend for general purpose automotive application including chassis & wheel bearings	450g
581201-64	Liplex EP2 Water Proof Grease High Temperature, Multipurpose Automotive and Industrial grease Recommend for general purpose automotive application including chassis & wheel Bearings	2.5kg
EC320	EP C3 Multipurpose Grease	20Ltr
EPC3450	EP C3 Multipurpose Grease	450g
71-020202-30	Drum SINOPEX Water Proof HPXT Grease Suitable for using in automotive wheel bearings & chassis points, particularly those operating under the high – temperature, high – load conditions.	20Ltr



Part No.	Description	Weight
30	CRC 5.56 Multipurpose Spray Can •Penetrant •Lubricant •Water dispersant •Rust preventative	400g
31	CRC Zinc IT Galvanic Rust Protection Spray Can: •Corrosion protection •Factor: 72	350g
CG400	Galmet Cold Metal Protection Zinc rich coating for the protection of steel against rust and corrosion	480g
42034002	Dy-Mark Multi-purpose Lubricant •Penetrant & lubricant •Rust preventative •Displaces moisture	400g
230732006	Dy-Mark Cold Galvanising Coating It is used extensively in metal fabrication and gives superior galvanic protection to new weld joints	400g



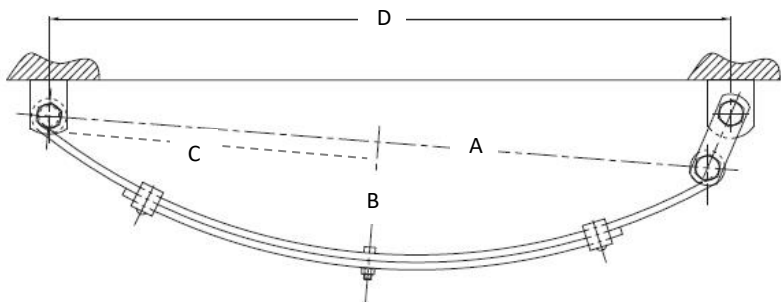

HANGER KIT



SPRINGS

1/2" AXLE FITTINGS

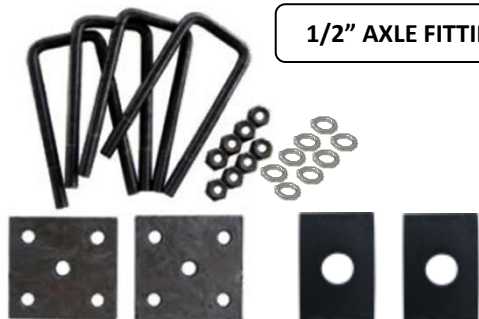

45MM x 8MM EYE to EYE SPRING SETS

PART NO.	DESCRIPTION	CARRYING CAPACITY	FINISH	A	B	C	D
SE456S	SET AK. 6L x 45mm x 8mm EYE to EYE SPRINGS	1500KG	BLACK	711mm	120mm	355mm	735mm
SE458S	SET AK. 8L x 45mm x 8mm EYE to EYE SPRINGS	1900KG	BLACK	711mm	120mm	355mm	735mm

PLEASE NOTE: SET OF SPRINGS INC. SPRINGS, HANGER KIT & 1/2" AXLE FITTINGS

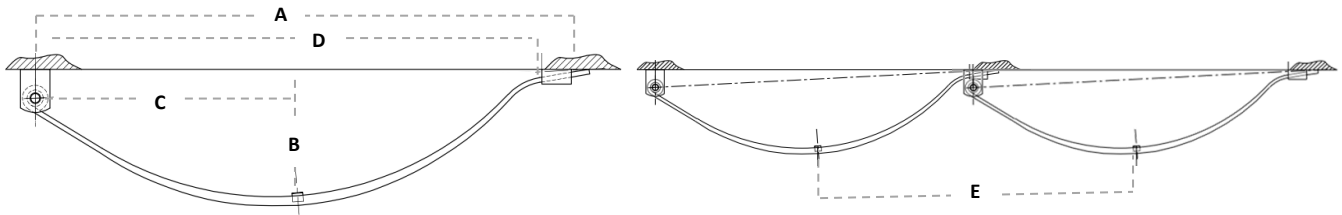

HANGER KIT



1/2" AXLE FITTINGS

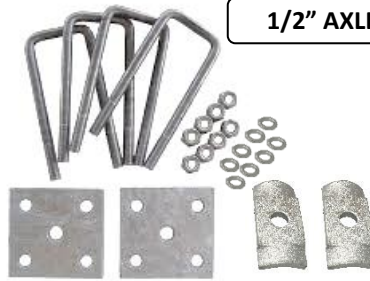

SPRINGS

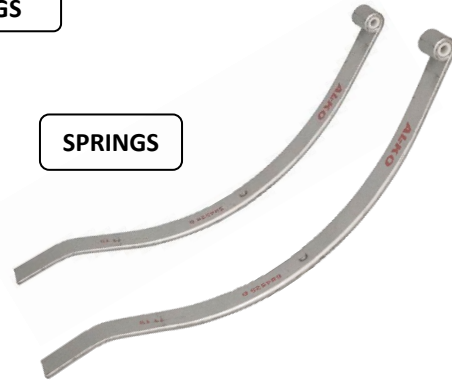

45MM DACROMET PARABOLIC SPRING SETS

PART NO.	DESCRIPTION	CARRYING CAPACITY	SPRING BUSH DIMENSIONS	A(mm)	B(mm)	C(mm)	D(mm)	E(mm)
SPBS600G	SET AK. 45mm x 13mm PARABOLIC SPRING	600KG	1/2" x 7/8" x 45mm	755	150	350	690	860
SPBS1000G	SET AK. 45mm x 15mm PARABOLIC SPRING	1000KG						
SPBS1400G	SET AK. 45mm x 18mm PARABOLIC SPRING	1400KG						

PLEASE NOTE: SET OF SPRINGS INC. SPRINGS, HANGER KIT & 1/2" AXLE FITTINGS

45MM DACROMET PARABOLIC SPRING ONLY

PART NO.	DESCRIPTION	CARRYING CAPACITY	SPRING BUSH DIMENSIONS	A(mm)	B(mm)	C(mm)	D(mm)	E mm)
SPB600G	AK. 45mm x 13mm PARABOLIC SPRING ONLY	300KG	1/2" x 7/8" x 45mm	755	150	350	690	860
SPB1000G	AK. 45mm x 15mm PARABOLIC SPRING ONLY	500KG						
SPB1400G	AK. 45mm x 18mm PARABOLIC SPRING ONLY	700KG						

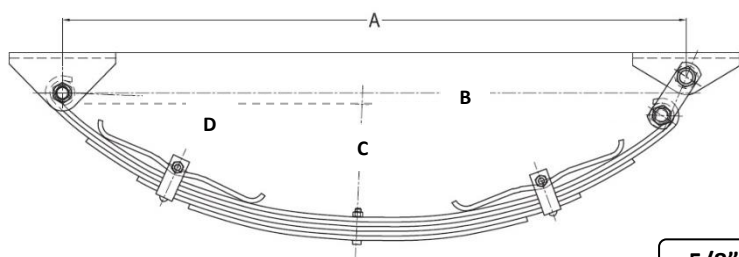

HANGER KIT

5/8" AXLE FITTINGS

SPRINGS



60MM BLACK OUTBACK SPRING SETS

PART NO.	DESCRIPTION	CARRYING CAPACITY	SINGLE AXLE SET UP DIMENSION "A" (NO LOAD)	B(mm)	C(mm)	D(mm)
SOB5S	SET AK. 5L x 60mm x 7mm EYE TO EYE OUTBACK SPRING	1150KG	865/875mm	841mm	158mm	420mm
SOB6S	SET AK. 6L x 60mm x 7mm EYE TO EYE OUTBACK SPRING	1350KG	865/875mm	841mm	158mm	420mm
SOB7S	SET AK. 7L x 60mm x 7mm EYE TO EYE OUTBACK SPRING	1550KG	865/875mm	841mm	158mm	420mm
SOB8S	SET AK. 8L x 60mm x 7mm EYE TO EYE OUTBACK SPRING	1750KG	865/875mm	841mm	158mm	420mm
SOB9S	SET AK. 9L x 60mm x 7mm EYE TO EYE OUTBACK SPRING	2000KG	865/875mm	841mm	158mm	420mm
SOB10S	SET AK. 10L x 60mm x 7mm EYE TO EYE OUTBACK SPRING	2500KG	865/875mm	841mm	158mm	420mm

PLEASE NOTE: SET OF SPRINGS INC. SPRINGS, HANGER KIT & 5/8" AXLE FITTINGS

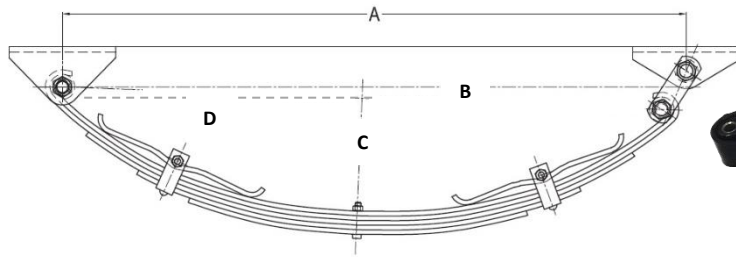

60MM BLACK OUTBACK SINGLE SPRING c/w HANGER KIT

PART NO.	DESCRIPTION	CARRYING CAPACITY	SINGLE AXLE SET UP DIMENSION "A" (NO LOAD)	B(mm)	C(mm)	D(mm)
SOB5	AK. 5L x 60mm x 7mm EYE TO EYE OUTBACK SPRING c/w HANGER KIT	575KG	865/875mm	841mm	158mm	420mm
SOB6	AK. 6L x 60mm x 7mm EYE TO EYE OUTBACK SPRING c/w HANGER KIT	675KG	865/875mm	841mm	158mm	420mm
SOB7	AK. 7L x 60mm x 7mm EYE TO EYE OUTBACK SPRING c/w HANGER KIT	775KG	865/875mm	841mm	158mm	420mm
SOB8	AK. 8L x 60mm x 7mm EYE TO EYE OUTBACK SPRING c/w HANGER KIT	875KG	865/875mm	841mm	158mm	420mm
SOB9	AK. 9L x 60mm x 7mm EYE TO EYE OUTBACK SPRING c/w HANGER KIT	1000KG	865/875mm	841mm	158mm	420mm
SOB10	AK. 10L x 60mm x 7mm EYE TO EYE OUTBACK SPRING c/w HANGER KIT	1250KG	865/875mm	841mm	158mm	420mm

PLEASE NOTE: SINGLE SPRING c/w HANGER KIT (NO AXLE FITTINGS)

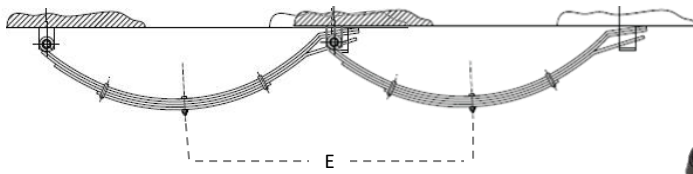
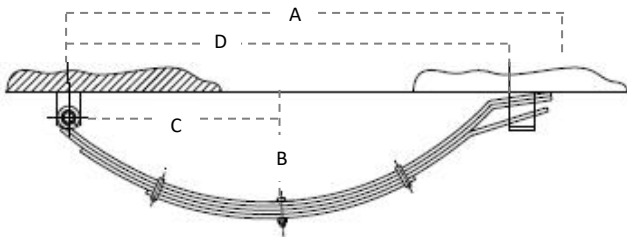

HANGER KIT

1/2" AXLE FITTINGS

SPRINGS

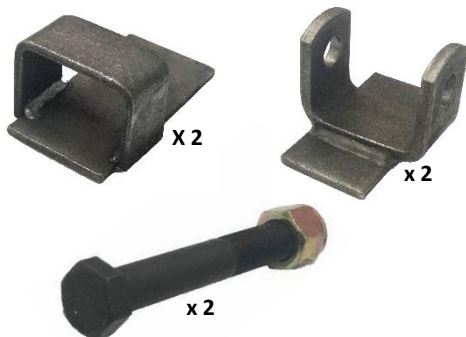

60MM x 6MM BLACK SLIPPER SPRING SETS

PART NO.	DESCRIPTION	CARRYING CAPACITY	SPRING BUSH DIMENSIONS	A(mm)	B(mm)	C(mm)	D(mm)	E(mm)
SS606S	SET AK. 6L x 60mm x 6mm SLIPPER SPRING *	1300KG	5/8" x 7/8" x 60mm	765	150	330	700	860
SS607S	SET AK. 7L x 60mm x 6mm SLIPPER SPRING *	1400KG						
SS609S	SET AK. 9L x 60mm x 6mm SLIPPER SPRING 🌿	1700KG						

PLEASE NOTE: SET OF SPRINGS INC. SPRINGS, HANGER KIT & 1/2" AXLE FITTINGS

🌿 PLEASE NOTE: SET OF 9L SLIPPER SPRING c/w HANGER KIT & 5/8" AXLE FITTINGS 🌿

60MM x 6MM BLACK SLIPPER SPRING ONLY

PART NO.	DESCRIPTION	CARRYING CAPACITY	SPRING BUSH DIMENSIONS	A(mm)	B(mm)	C(mm)	D(mm)	E(mm)
SS606	AK. 6L x 60mm x 6mm SLIPPER SPRING ONLY	650KG	5/8" x 7/8" x 60mm	765	150	330	700	860
SS607	AK. 7L x 60mm x 6mm SLIPPER SPRING ONLY	700KG						
SS609	AK. 9L x 60mm x 6mm SLIPPER SPRING ONLY	850KG						

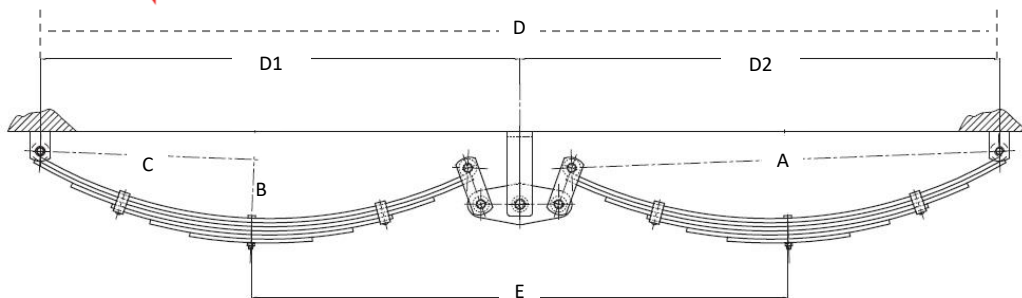

HANGER KIT

1/2" AXLE FITTING



60MM x 6MM BLACK TANDEM ROCKER SPRING SETS

PART NO.	DESCRIPTION	CARRYING CAPACITY	A(mm)	B(mm)	C(mm)	D(mm)	D1=D2 (mm)	E(mm)
SR605-14S	SET AK. 5L x 60mm x 6mm TANDEM ROCKER SPRING	2000KG	700	120	386	1650	825	893
SR606-14S	SET AK. 6L x 60mm x 6mm TANDEM ROCKER SPRING	3000KG						
SR607-14S	SET AK. 7L x 60mm x 6mm TANDEM ROCKER SPRING	3400KG						

PLEASE NOTE: SET OF SPRINGS INC. SPRINGS, HANGER KIT & 1/2" AXLE FITTINGS

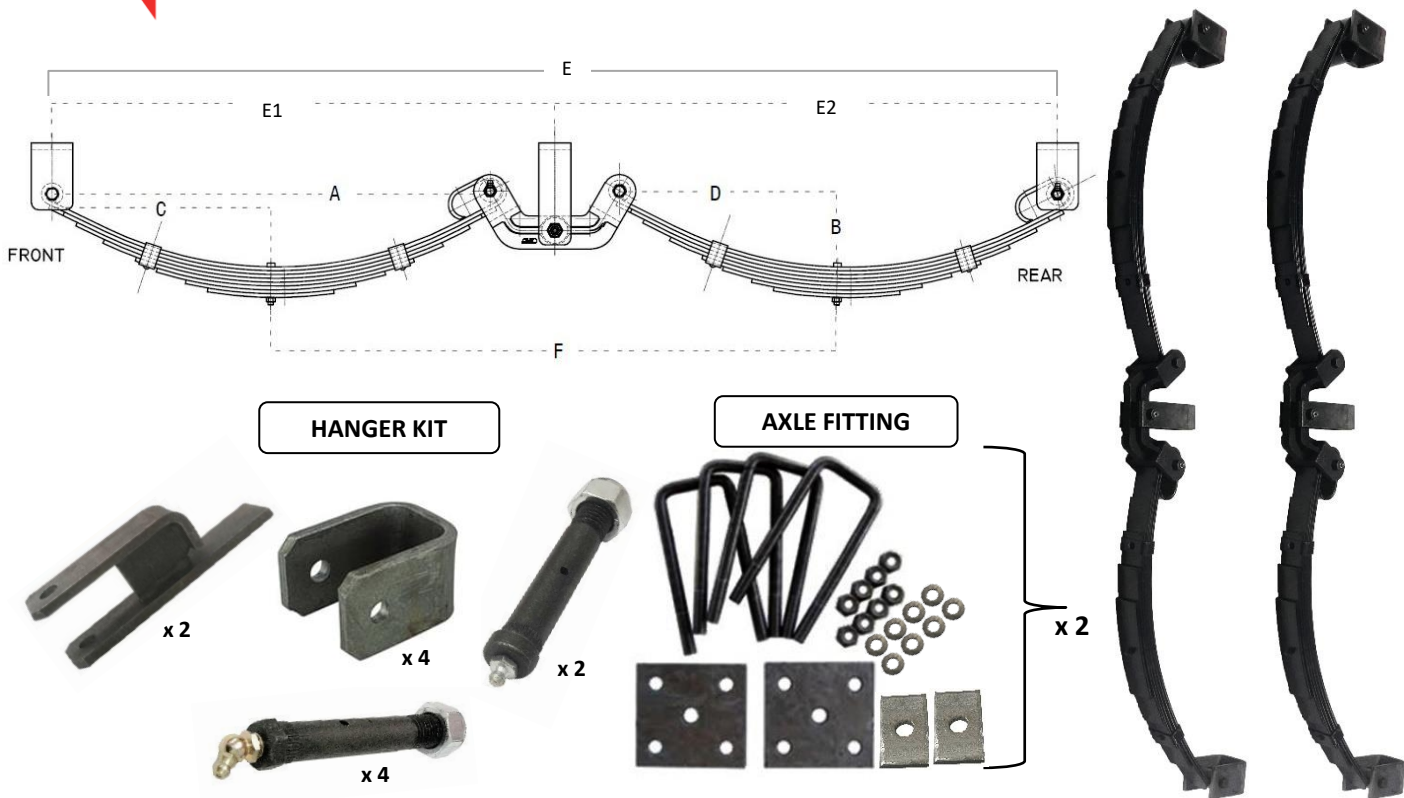

60MM x 6MM BLACK TANDEM ROCKER ROLLER SPRING SETS

PART NO.	DESCRIPTION	CARRYING CAPACITY	A(mm)	B(mm)	C(mm)	D(mm)	E(mm)	E1=E2 (mm)	F(mm)	
SRR605-14S	SET AK. 5L x 60mm x 6mm TANDEM ROCKER ROLLER SPRING*	1900-2200KG	687	117	396	291	1574	787	785	
SRR606-14S	SET AK. 6L x 60mm x 6mm TANDEM ROCKER ROLLER SPRING*	2210-2500KG								
SRR607-14S	SET AK. 7L x 60mm x 6mm TANDEM ROCKER ROLLER SPRING*	2600-3000KG								
SRR606-16S	SET AK. 6L x 60mm x 6mm TANDEM ROCKER ROLLER SPRING*	2900-3200KG			343	343				888
SRR607-16S	SET AK. 7L x 60mm x 6mm TANDEM ROCKER ROLLER SPRING*	3250-4200KG								
SRR608-16S	SET AK. 8L x 60mm x 6mm TANDEM ROCKER ROLLER SPRING*	3800-4490KG								

PLEASE NOTE: SET OF SPRINGS INC. SPRINGS, HANGER KIT & 1/2" AXLE FITTINGS

PLEASE NOTE: SET OF 8L TDM R/ROLLER SPRINGS c/w HANGER KIT & 5/8" AXLE FITTINGS

AK HANGERS



590630

FRONT HANGER TO
SUIT 60MM OUTBACK
SPRING



590631

REAR HANGER TO
SUIT 60MM OUTBACK
SPRING



576302

FRONT HANGER &
REAR HANGER TO
SUIT 60MM T/R/R
SPRING



590703

AK CENTRE ROCKER POST
ONLY SUIT 18MM PIN &
T/R SPRING



576305

AK CENTRE ROLLER ROCKER
POST ONLY SUIT 18MM PIN
& T/R/R SPRING

AK ARM



590705

AK ROCKER ARM ONLY
SUIT 60MM SPRING &
18MM PIN



576303

AK ROLLER ROCKER ARM
ONLY SUIT 60MM SPRING
& 18MM PIN

AK PIN



(ROUND HEAD)

590711/12

AK 18MM x 100MM GREASER
PIN c/w NYLOC NUT TO SUIT
T/R SPRING



590707/8

AK M16MM x 100MM DRY
SHACKLE PIN & NYLOC NUT
TO SUIT T/R SPRING



(HEX HEAD)

576306/12

AK M18MM x 97MM CENTER
GREASER PIN c/w NYLOC NUT TO
SUIT T/R/R SPRING



576304/590708

AK M16 GREASER PIN &
NYLOC NUT TO SUIT T/R/R
SPRING



590632/708

AK M16 x 100MM GREASER
PIN c/w NYLOC NUT TO
SUIT OUTBACK SPRING

AK BUSHES



590633

STEEL BUSH TO SUIT
60MM OUTBACK
SPRING



576301

ROCKER ROLLER
BUSH



590003

16MM x 22MM x
60MM NYLON BUSH
TO SUIT T/R & T/R/R
SPRING

AK FISHPLATE, SHACKLE PLATE & AXLE PAD



590633

SHACKLE PLATE SUIT TO
60MM OUTBACK T/R
SPRING & 16MM PIN



590510/6

FLAT AXLE PAD 8MM
& 10MM



590420

SLOTTED FISHPLATE
60MM x 45 & 50MM

AK U-BOLTS, NUT & WASHER



592506

5/8" U-BOLT c/w NW SUIT 50
SQUARE (170MM LONG)



592455

5/8" U-BOLT c/w NW SUIT 45
SQUARE (160MM LONG)

AK SET OF U-BOLTS c/w NW, AXLE PAD & FISHPLATES

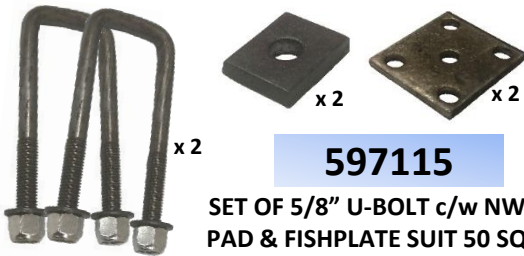

597115

SET OF 5/8" U-BOLT c/w NW AXLE
PAD & FISHPLATE SUIT 50 SQUARE



597115

SET OF 5/8" U-BOLT c/w NW AXLE
PAD & FISHPLATE SUIT 45 SQUARE

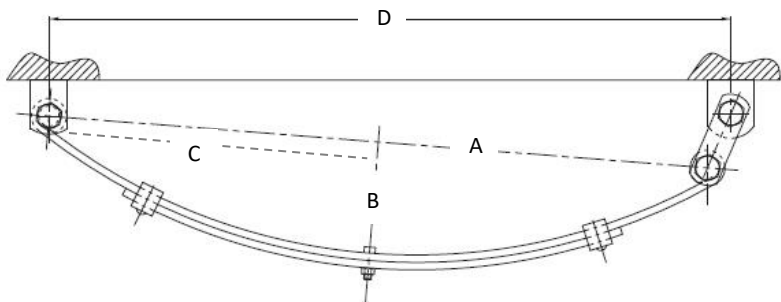

HANGER KIT

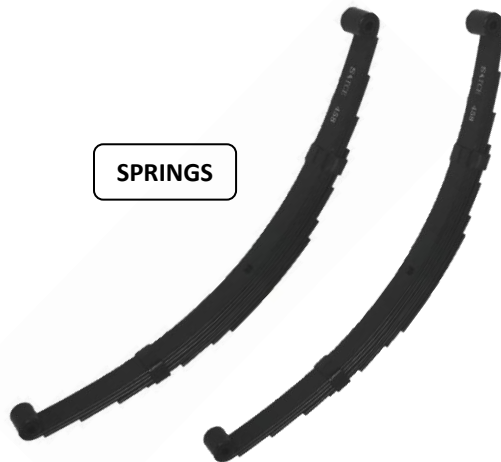

SPRINGS



1/2" AXLE FITTINGS

45MM EYE TO EYE SPRING SETS

PART NO.	DESCRIPTION	CARRYING CAPACITY	FINISH	A	B	C	D
SASE456S	SET SAT 6L x 45mm EYE to EYE SPRINGS	750KG	BLACK	716mm	145mm	367mm	722mm
SASE458S	SET SAT 8L x 45mm EYE to EYE SPRINGS	950KG					
SASE4510S	SET SAT 10L x 45mm EYE to EYE SPRINGS	1270KG					

PLEASE NOTE: SET OF SPRINGS INC. SPRINGS, HANGER KIT & 1/2" AXLE FITTINGS

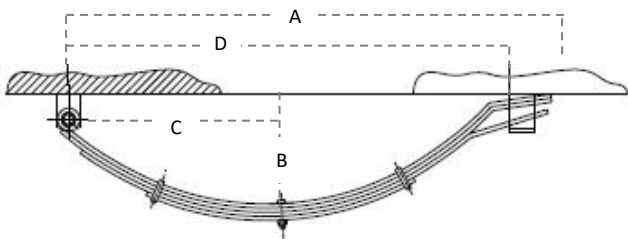

HANGER KIT

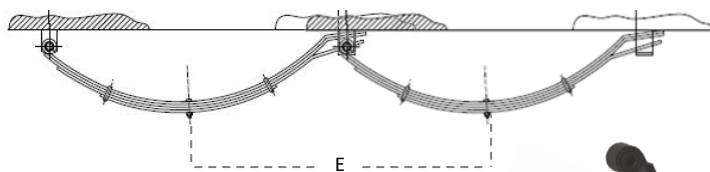

1/2" AXLE FITTINGS



SPRINGS

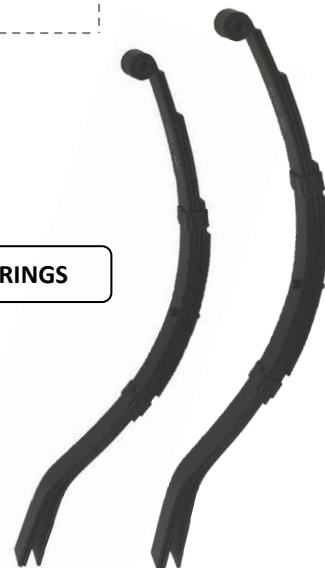

45MM BLACK SLIPPER SPRING SETS

PART NO.	DESCRIPTION	SPRING BUSH DIMENSIONS	CARRYING CAPACITY	A(mm)	B(mm)	C(mm)	D(mm)	E(mm)
SASS453S	SET SAT 3L x 45mm SLIPPER SPRING	7/8" x 1/2" x 45mm	500KG	765	155	330	700	725
SASS454S	SET SAT 4L x 45mm SLIPPER SPRING		700KG					
SASS455S	SET SAT 5L x 45mm SLIPPER SPRING		1000KG					
SASS456S	SET SAT 6L x 45mm SLIPPER SPRING		1120KG					
SASS457S	SET SAT 7L x 45mm SLIPPER SPRING		1270KG					
SASS458S	SET SAT 8L x 45mm SLIPPER SPRING		1375KG					
SASS459S	SET SAT 9L x 45mm SLIPPER SPRING		1500KG					

PLEASE NOTE: SET OF SPRINGS INC. SPRINGS, HANGER KIT & 1/2" AXLE FITTINGS

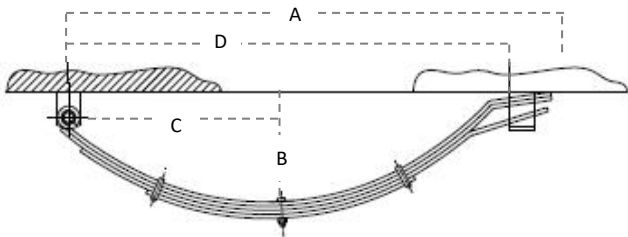

45MM BLACK SLIPPER SPRING ONLY

PART NO.	DESCRIPTION	SPRING BUSH DIMENSIONS	CARRYING CAPACITY	A(mm)	B(mm)	C(mm)	D(mm)
SASS453	SET SAT 3L x 45mm SLIPPER SPRING ONLY	7/8" x 1/2" x 45mm	250KG	765	155	330	700
SASS454	SET SAT 4L x 45mm SLIPPER SPRING		350KG				
SASS455	SET SAT 5L x 45mm SLIPPER SPRING ONLY		500KG				
SASS456	SET SAT 6L x 45mm SLIPPER SPRING ONLY		560KG				
SASS457	SET SAT 7L x 45mm SLIPPER SPRING ONLY		635KG				
SASS458	SET SAT 8L x 45mm SLIPPER SPRING ONLY		688KG				
SASS459	SET SAT 9L x 45mm SLIPPER SPRING ONLY		750KG				

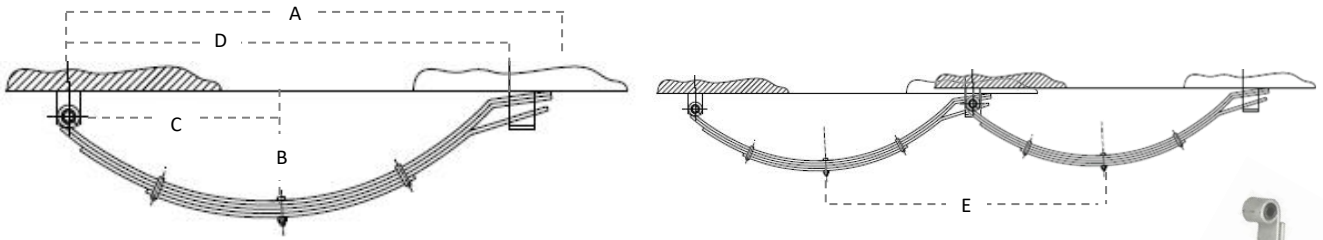

GALV HANGER KIT

GALV 1/2" AXLE FITTINGS

SPRINGS

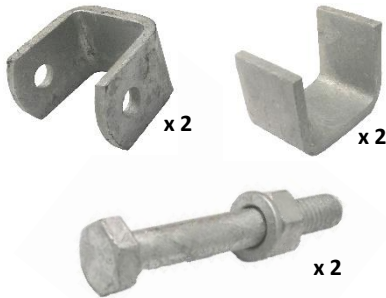

45MM DACROMET SLIPPER SPRING SETS

PART NO.	DESCRIPTION	SPRING BUSH DIMENSIONS	CARRYING CAPACITY	A(mm)	B(mm)	C(mm)	D(mm)	E(mm)
SASS453SG	SET SAT 3L x 45mm DAC SLIPPER SPRING	7/8" x 1/2" x 45mm	500KG	765	155	330	700	725
SASS454SG	SET SAT 4L x 45mm DAC SLIPPER SPRING		700KG					
SASS455SG	SET SAT 5L x 45mm DAC SLIPPER SPRING		1000KG					
SASS456SG	SET SAT 6L x 45mm DAC SLIPPER SPRING		1120KG					
SASS457SG	SET SAT 7L x 45mm DAC SLIPPER SPRING		1270KG					
SASS459SG	SET SAT 9L x 45mm DAC SLIPPER SPRING		1500KG					

PLEASE NOTE: SET OF SPRINGS INC. SPRINGS, GALV HANGER KIT & GALV 1/2" AXLE FITTINGS

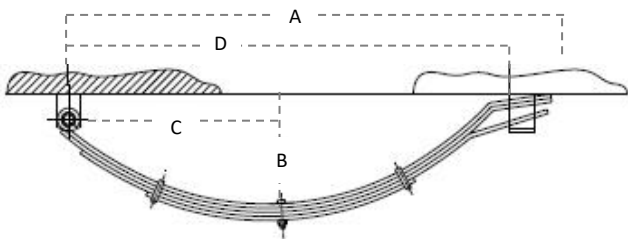

45MM DACROMET SLIPPER SPRING ONLY

PART NO.	DESCRIPTION	SPRING BUSH DIMENSIONS	CARRYING CAPACITY	A(mm)	B(mm)	C(mm)	D(mm)
SASS453G	SET SAT 3L x 45mm DAC SLIPPER SPRING ONLY	7/8" x 1/2" x 45mm	500KG	765	155	330	700
SASS454G	SET SAT 4L x 45mm DAC SLIPPER SPRING ONLY		700KG				
SASS455G	SET SAT 5L x 45mm DAC SLIPPER SPRING ONLY		1000KG				
SASS456G	SET SAT 6L x 45mm DAC SLIPPER SPRING ONLY		1120KG				
SASS457G	SET SAT 7L x 45mm DAC SLIPPER SPRING ONLY		1270KG				
SASS459G	SET SAT 9L x 45mm DAC SLIPPER SPRING ONLY		1500KG				

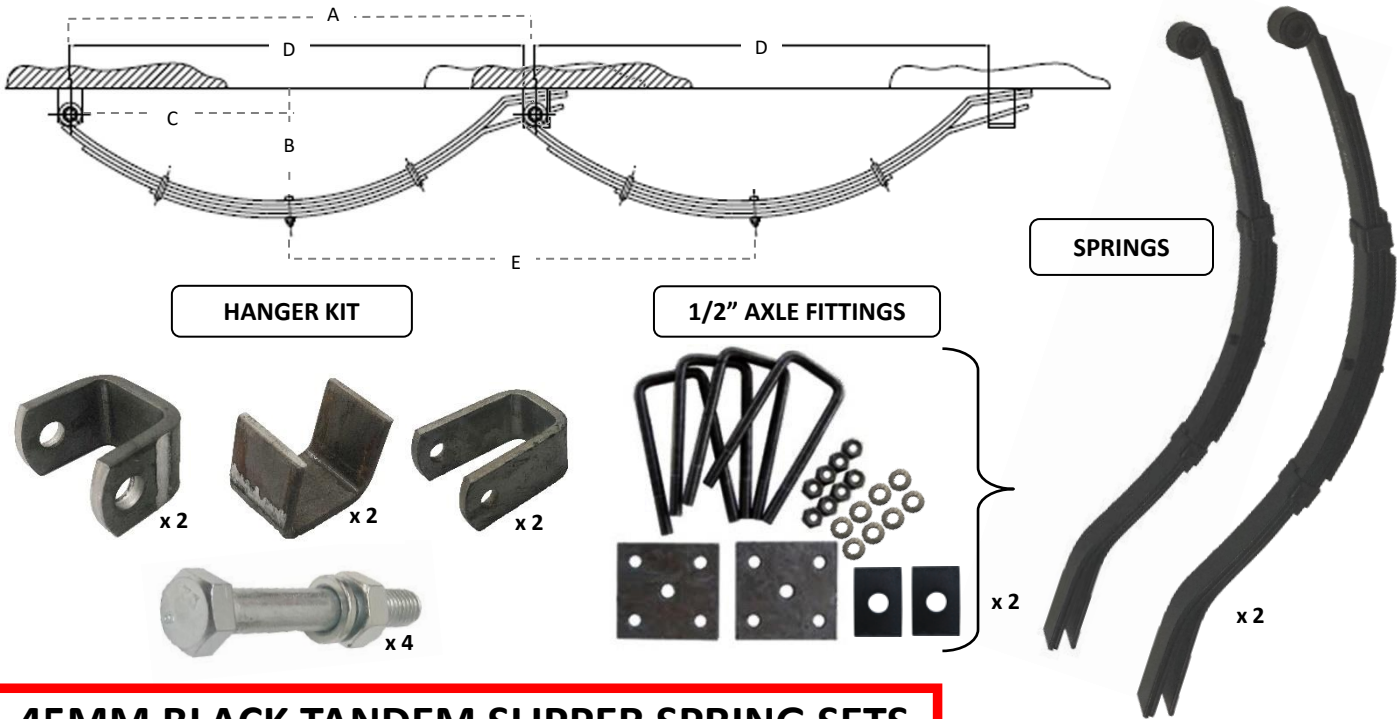

45MM BLACK TANDEM SLIPPER SPRING SETS

PART NO.	DESCRIPTION	SPRING BUSH DIMENSIONS	CARRYING CAPACITY	A(mm)	B(mm)	C(mm)	D(mm)	E(mm)
SASST453S	SET SAT 3L x 45mm TANDEM SLIPPER SPRING	7/8" x 1/2" x 45mm	1000KG	765	155	330	700	707
SASST454S	SET SAT 4L x 45mm TANDEM SLIPPER SPRING		1400KG					
SASST455S	SET SAT 5L x 45mm TANDEM SLIPPER SPRING		2000KG					
SASST456S	SET SAT 6L x 45mm TANDEM SLIPPER SPRING		2240KG					
SASST457S	SET SAT 7L x 45mm TANDEM SLIPPER SPRING		2540KG					
SASST458S	SET SAT 8L x 45mm TANDEM SLIPPER SPRING		2750KG					
SASST459S	SET SAT 9L x 45mm TANDEM SLIPPER SPRING		3000KG					

PLEASE NOTE: SET OF SPRINGS INC. SPRINGS, HANGER KIT & 1/2" AXLE FITTINGS

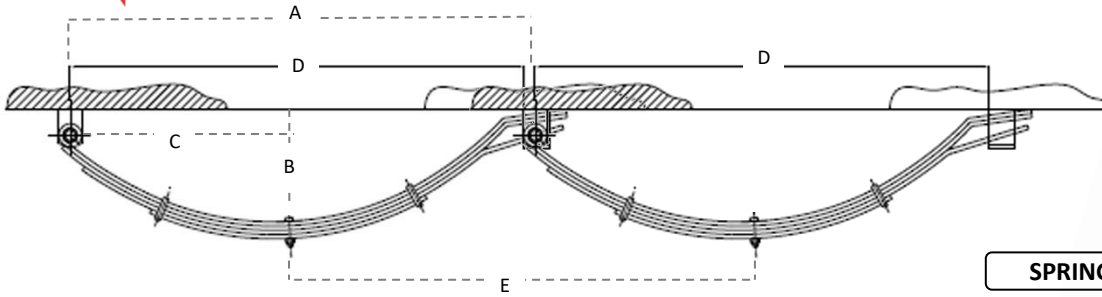

GALV HANGER KIT

GALV 1/2" AXLE FITTINGS

SPRINGS

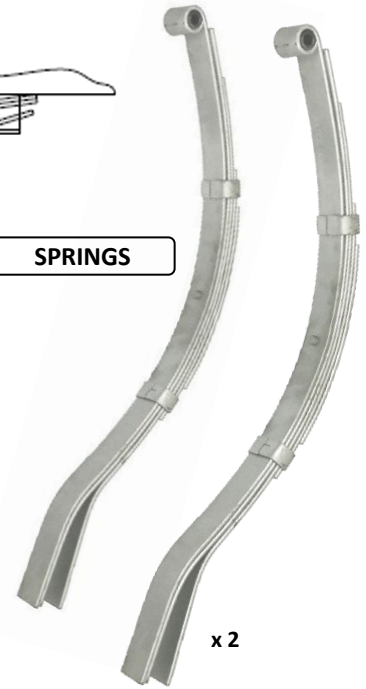
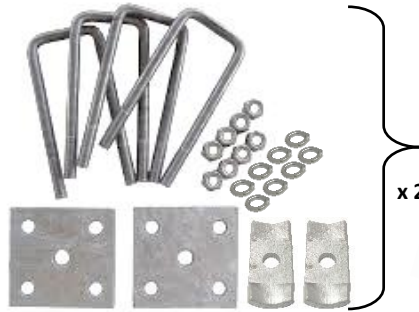
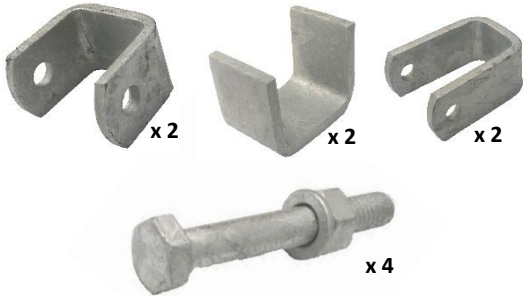

45MM DACROMET TANDEM SLIPPER SPRING SETS

PART NO.	DESCRIPTION	SPRING BUSH DIMENSIONS	CARRYING CAPACITY	A(mm)	B(mm)	C(mm)	D(mm)	E(mm)
SASST453SG	SET SAT 3L x 45mm DAC TANDEM SLIPPER SPRING	7/8" x 1/2" x 45mm	1000KG	765	155	330	700	707
SASST454SG	SET SAT 4L x 45mm DAC TANDEM SLIPPER SPRING		1400KG					
SASST455SG	SET SAT 5L x 45mm DAC TANDEM SLIPPER SPRING		2000KG					
SASST456SG	SET SAT 6L x 45mm DAC TANDEM SLIPPER SPRING		2240KG					
SASST457SG	SET SAT 7L x 45mm DAC TANDEM SLIPPER SPRING		2540KG					
SASST459SG	SET SAT 9L x 45mm DAC TANDEM SLIPPER SPRING		3000KG					

PLEASE NOTE: SET OF SPRINGS INC. SPRINGS, GALV HANGER KIT & GALV 1/2" AXLE FITTINGS

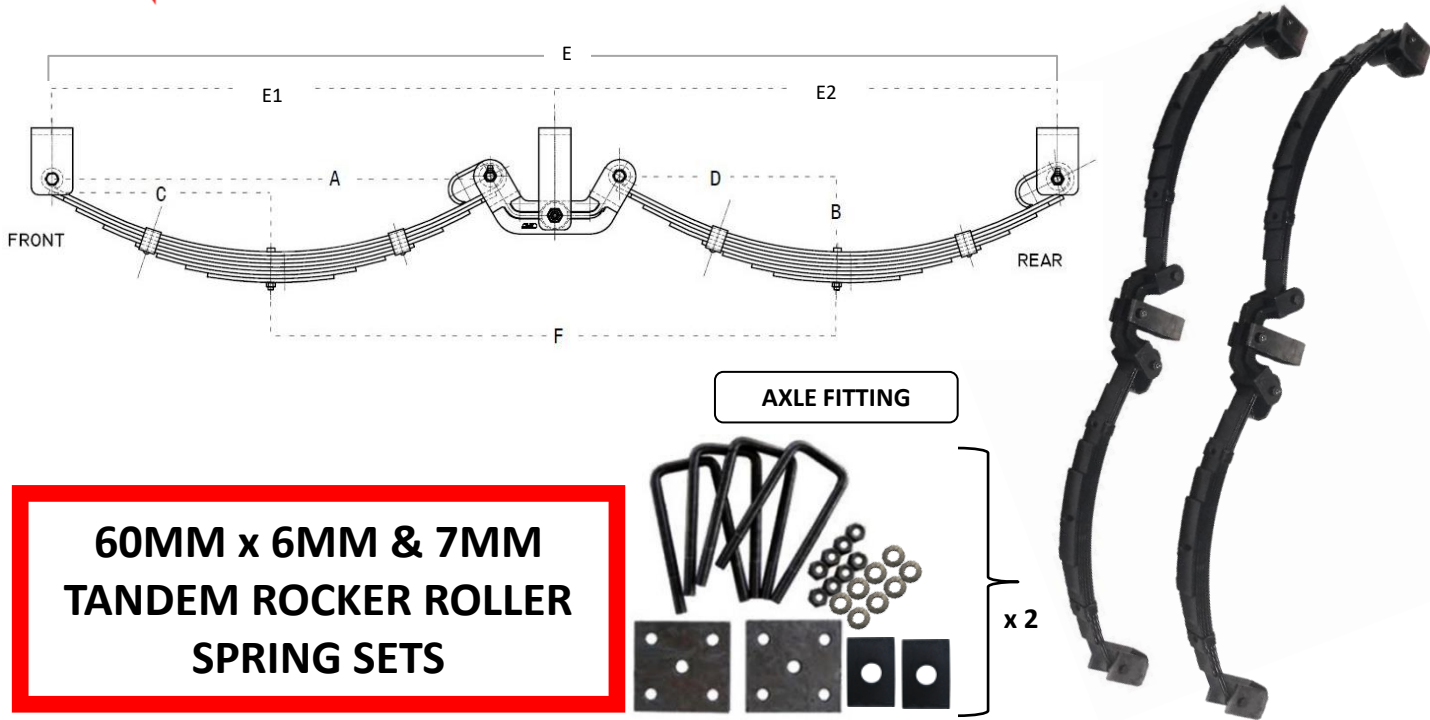

**60MM x 6MM & 7MM
TANDEM ROCKER ROLLER
SPRING SETS**

PART NO.	DESCRIPTION	CARRYING CAPACITY	A(mm)	B(mm)	C(mm)	D(mm)	E(mm)	E1=E2 (mm)	F(mm)
SASRR605-14S	SET SAT 5L x 60mm x 6mm TANDEM ROCKER ROLLER SPRING (14") *	2000KG	695	102	395	290	1584	795	795
SASRR606-14S	SET SAT 6L x 60mm x 6mm TANDEM ROCKER ROLLER SPRING (14") *	2500KG							
SASRR607-14S	SET SAT 7L x 60mm x 6mm TANDEM ROCKER ROLLER SPRING (14") *	3000KG							
SASRR608-14S	SET SAT 8L x 60mm x 6mm TANDEM ROCKER ROLLER SPRING (14") *	4000KG							
SASRR606-16S	SET SAT 6L x 60mm x 7mm TANDEM ROCKER ROLLER SPRING (16") *	2500KG	690	102	345	360	1584	795	920
SASRR607-16S	SET SAT 7L x 60mm x 7mm TANDEM ROCKER ROLLER SPRING (16") *	3000KG							
SASRR608-16S	SET SAT 8L x 60mm x 7mm TANDEM ROCKER ROLLER SPRING (16") *	4000KG							
SASRR609-16S	SET SAT 9L x 60mm x 7mm TANDEM ROCKER ROLLER SPRING (16") *	4500KG							

PLEASE NOTE: SET OF SPRINGS INC. SPRINGS c/w HANGER & 1/2" AXLE FITTINGS

PLEASE NOTE: SET OF 8L & 9L (16") TDM R/ROLLER SPRINGS c/w HANGER & 5/8" AXLE FITTINGS

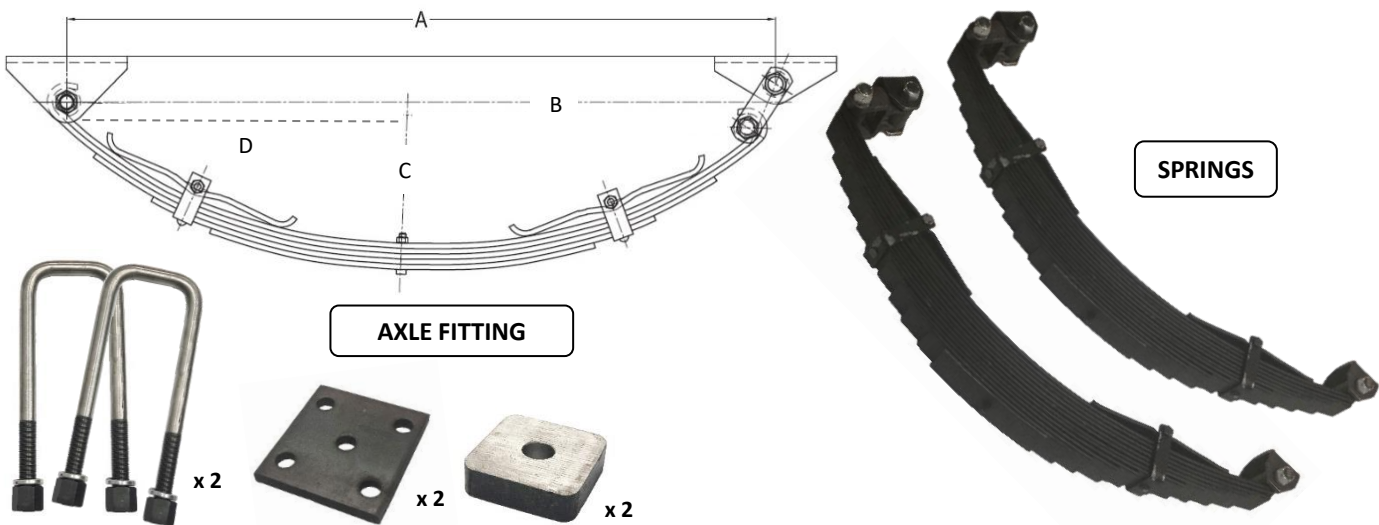

60MM x 8MM EYE TO EYE SPRING SETS

PART NO.	DESCRIPTION	CARRYING CAPACITY	FINISH	A(MM)	B(MM)	C(MM)	D(MM)
SM6013EES	SET MT. 13L x 60mm x 8mm EYE TO EYE SPRING	3000KG	BLACK	900	470	130	465

**SQUARE BLACK U-BOLT c/w
NUTS & WASHERS**

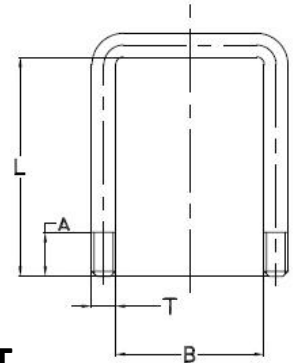

SQUARE U-BOLT

PART NO.	AXLE SECTION "B"	U BOLT LENGTH "L"	NORMAL THREAD LENGTH "A"	THREAD TYPE "T"	FINISH
UB4035SQ	40MM	3.1/2"/89MM	50MM	1/2" BSW	BLACK
UB4045SQ	40MM	4.1/2"/115MM	50MM	1/2" BSW	BLACK
UB405SQ	40MM	5"/127MM	50MM	1/2" BSW	BLACK
UB4055SQ	40MM	5.1/2"/140MM	50MM	1/2" BSW	BLACK
UB4535SQ	45MM	3.1/2"/89MM	50MM	1/2" BSW	BLACK
UB4545SQ	45MM	4.1/2"/115MM	50MM	1/2" BSW	BLACK
UB455SQ	45MM	5"/127MM	50MM	1/2" BSW	BLACK
UB4555SQ	45MM	5.1/2"/140MM	50MM	1/2" BSW	BLACK
UB456SQ	45MM	6"/153MM	50MM	1/2" BSW	BLACK
UB5045SQ	50MM	4.1/2"/115MM	50MM	1/2" BSW	BLACK
UB505SQ	50MM	5"/127MM	50MM	1/2" BSW	BLACK
UB5055SQ	50MM	5.1/2"/140MM	50MM	1/2" BSW	BLACK
UB506SQ	50MM	6"/165MM	50MM	1/2" BSW	BLACK
UB5065SQ	50MM	6.1/2"/153MM	50MM	1/2" BSW	BLACK

**ROUND BLACK U-BOLT c/w
NUTS & WASHERS**

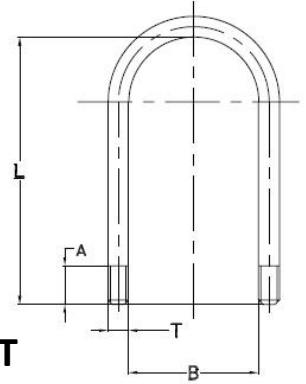

ROUND U-BOLT

PART NO.	AXLE SECTION "B"	U BOLT LENGTH "L"	NORMAL THREAD LENGTH "A"	THREAD TYPE "T"	FINISH
UB3935RD	39MM	3.1/2"/89MM	50MM	1/2" BSW	BLACK
UB394RD	39MM	4"/115MM	50MM	1/2" BSW	BLACK
UB3945RD	39MM	4.1/2"/102MM	50MM	1/2" BSW	BLACK
UB395RD	39MM	5"/127MM	50MM	1/2" BSW	BLACK
UB3955RD	39MM	5.1/2"/140MM	50MM	1/2" BSW	BLACK
UB5045RD	50MM	4.1/2"/115MM	50MM	1/2" BSW	BLACK
UB505RD	50MM	5"/127MM	50MM	1/2" BSW	BLACK
UB5055RD	50MM	5.1/2"/140MM	50MM	1/2" BSW	BLACK
UB506RD	50MM	6"/153MM	50MM	1/2" BSW	BLACK

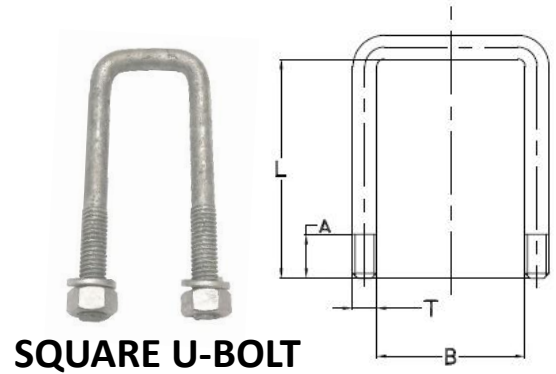

SQUARE U-BOLT

**SQUARE GALVANISED
 U-BOLT c/w NUTS & WASHERS**

PART NO.	AXLE SECTION "B"	U BOLT LENGTH "L"	NORMAL THREAD LENGTH "A"	THREAD TYPE "T"	FINISH
UB4035SQG	40MM	3.1/2"/89MM	50MM	1/2" BSW	GALVANISED
UB4045SQG	40MM	4.1/2"/115MM	50MM	1/2" BSW	GALVANISED
UB405SQG	40MM	5"/127MM	50MM	1/2" BSW	GALVANISED
UB4055SQG	40MM	5.1/2"/140MM	50MM	1/2" BSW	GALVANISED
UB4535SQG	45MM	3.1/2"/89MM	50MM	1/2" BSW	GALVANISED
UB4545SQG	45MM	4.1/2"/115MM	50MM	1/2" BSW	GALVANISED
UB455SQG	45MM	5"/127MM	50MM	1/2" BSW	GALVANISED
UB4555SQG	45MM	5.1/2"/140MM	50MM	1/2" BSW	GALVANISED
UB5045SQG	50MM	4.1/2"/115MM	50MM	1/2" BSW	GALVANISED
UB505SQG	50MM	5"/127MM	50MM	1/2" BSW	GALVANISED
UB506SQG	50MM	6"/153MM	50MM	1/2" BSW	GALVANISED

**ROUND GALVANISED
 U-BOLT c/w NUTS & WASHERS**

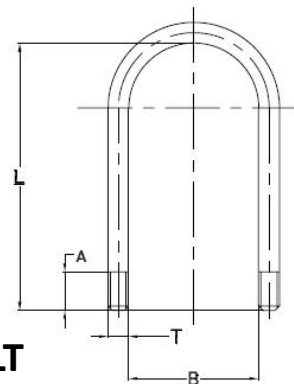

ROUND U-BOLT

PART NO.	AXLE SECTION "B"	U BOLT LENGTH "L"	NORMAL THREAD LENGTH "A"	THREAD TYPE "T"	FINISH
UB3935RDG	39MM	3.1/2"/89MM	50MM	1/2" BSW	GALVANISED
UB3945RDG	39MM	4.1/2"/115MM	50MM	1/2" BSW	GALVANISED
UB395RDG	39MM	5"/127MM	50MM	1/2" BSW	GALVANISED
UB3955RDG	39MM	5.1/2"/140MM	50MM	1/2" BSW	GALVANISED
UB4535RDG	45MM	3.1/2"/89MM	50MM	1/2" BSW	GALVANISED
UB455RDG	45MM	5"/127MM	50MM	1/2" BSW	GALVANISED
UB4555RDG	45MM	5.1/2"/140MM	50MM	1/2" BSW	GALVANISED
UB5045RDG	50MM	4.1/2"/115MM	50MM	1/2" BSW	GALVANISED

FRONT BOLTS & NUTS c/w WASHERS



PART NO.	DESCRIPTION	FINISH
FBNW	FRONT BOLT c/w NUT WASHER (3.1/2" x 1/2")	ZINC
FBNWG	FRONT BOLT GALV c/w NUT WASHER (3.1/2" x 1/2")	GALV

WHIT BOLTS c/w NUTS



PART NO.	DESCRIPTION	FINISH
BN1.5/12	1.1/2" x 1/2" WHIT BOLT c/w NUT	ZINC
BN3.5/12	3.1/2 x 1/2" WHIT BOLT c/w NUT	ZINC
BN4.5/12	4.1/2 x 1/2" WHIT BOLT c/w NUT	ZINC

NUTS & SPRING WASHERS



NUT

WASHER

PART NO.	DESCRIPTION	FINISH
29	1/2" HEX NUT ONLY	ZINC
SWASS12	1/2" SPRING WASHER	ZINC
SWASS38	3/8" SPRING WASHER	ZINC
SWASS716	7/16" SPRING WASHER	ZINC
29G	1/2" GALV HEX NUT ONLY	GALV
SWASS12G	1/2" GALV SPRING WASHER	GALV
SWASS38G	3/8" GALV SPRING WASHER	GALV
SWASS716G	7/16" GALV SPRING WASHER	GALV

**SET OF SQUARE BLACK U-BOLT
c/w NUTS, WASHERS,
FISHPLATES & AXLE PADS**

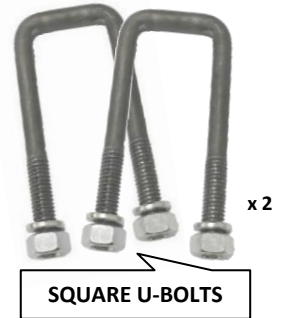
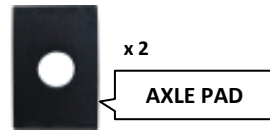
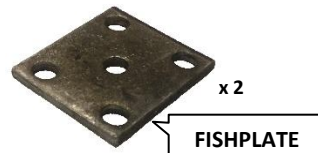

PART NO.

DESCRIPTION

UB4035SSQ	SET OF 40MM SQ x 3.1/2" U-BOLTS c/w NUTS, WASHERS, FISHPLATES & AXLE PADS
UB4045SSQ	SET OF 40MM SQ x 4.1/2" U-BOLTS c/w NUTS, WASHERS, FISHPLATES & AXLE PADS
UB405SSQ	SET OF 40MM SQ x 5" U-BOLTS c/w NUTS, WASHERS, FISHPLATES & AXLE PADS
UB4055SSQ	SET OF 40MM SQ x 5.1/2" U-BOLTS c/w NUTS, WASHERS, FISHPLATES & AXLE PADS
UB4535SSQ	SET OF 45MM SQ x 3.1/2" U-BOLTS c/w NUTS, WASHERS, FISHPLATES & AXLE PADS
UB4545SSQ	SET OF 45MM SQ x 4.1/2" U-BOLTS c/w NUTS, WASHERS, FISHPLATES & AXLE PADS
UB455SSQ	SET OF 45MM SQ x 5" U-BOLTS c/w NUTS, WASHERS, FISHPLATES & AXLE PADS
UB4555SSQ	SET OF 45MM SQ x 5.1/2" U-BOLTS c/w NUTS, WASHERS, FISHPLATES & AXLE PADS
UB456SSQ	SET OF 45MM SQ x 6" U-BOLTS c/w NUTS, WASHERS, FISHPLATES & AXLE PADS
UB5045SSQ	SET OF 50MM SQ x 4.1/2" U-BOLTS c/w NUTS, WASHERS, FISHPLATES & AXLE PADS
UB505SSQ	SET OF 50MM SQ x 5" U-BOLTS c/w NUTS, WASHERS, FISHPLATES & AXLE PADS
UB5055SSQ	SET OF 50MM SQ x 5.1/2" U-BOLTS c/w NUTS, WASHERS, FISHPLATES & AXLE PADS
UB506SSQ	SET OF 50MM SQ x 6" U-BOLTS c/w NUTS, WASHERS, FISHPLATES & AXLE PADS
UB5065SSQ	SET OF 50MM SQ x 6.1/2" U-BOLTS c/w NUTS, WASHERS, FISHPLATES & AXLE PADS

**SET OF ROUND BLACK U-BOLT
 c/w NUTS, WASHERS,
 FISHPLATE & AXLE PADS**

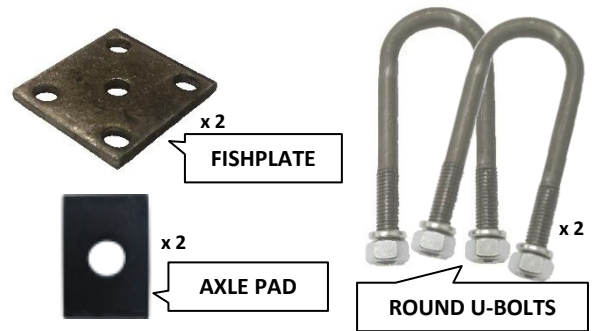

PART NO.	DESCRIPTION
UB3935SRD	SET OF 39MM RD x 3.1/2" U-BOLTS c/w NUTS, WASHERS, FISHPLATES & AXLE PADS
UB3945SRD	SET OF 39MM RD x 4.1/2" U-BOLTS c/w NUTS, WASHERS, FISHPLATES & AXLE PADS
UB394SRD	SET OF 39MM RD x 4" U-BOLTS c/w NUTS, WASHERS, FISHPLATES & AXLE PADS
UB395SRD	SET OF 39MM RD x 5" U-BOLTS c/w NUTS, WASHERS, FISHPLATES & AXLE PADS
UB3955SRD	SET OF 39MM RD x 5.1/2" U-BOLTS c/w NUTS, WASHERS, FISHPLATES & AXLE PADS
UB5045SRD	SET OF 50MM RD x 4.1/2" U-BOLTS c/w NUTS, WASHERS, FISHPLATES & AXLE PADS
UB505SRD	SET OF 50MM RD x 5" U-BOLTS c/w NUTS, WASHERS, FISHPLATES & AXLE PADS
UB5055SRD	SET OF 50MM RD x 5.1/2" U-BOLTS c/w NUTS, WASHERS, FISHPLATES & AXLE PADS
UB506SRD	SET OF 50MM RD x 6" U-BOLTS c/w NUTS, WASHERS, FISHPLATES & AXLE PADS

**SET OF SQUARE GALVANISED
U-BOLT c/w NUTS, WASHERS,
FISHPLATES & AXLE PADS**

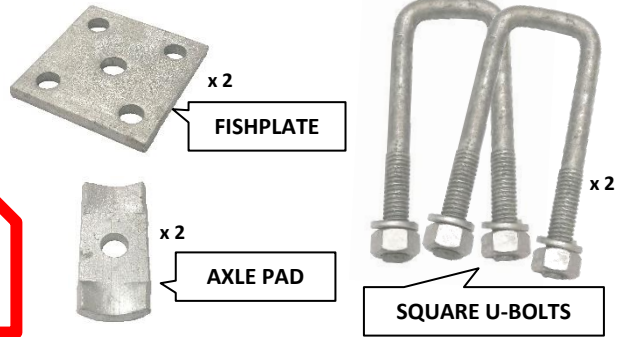

PART NO.

DESCRIPTION

UB4035SSQG	SET OF 40MM SQ x 3.1/2" U-BOLTS c/w NUTS, WASHERS, FISHPLATES & AXLE PADS
UB4045SSQG	SET OF 40MM SQ x 4.1/2" U-BOLTS c/w NUTS, WASHERS, FISHPLATES & AXLE PADS
UB405SSQG	SET OF 40MM SQ x 5" U-BOLTS c/w NUTS, WASHERS, FISHPLATES & AXLE PADS
UB4055SSQG	SET OF 40MM SQ x 5.1/2" U-BOLTS c/w NUTS, WASHERS, FISHPLATES & AXLE PADS
UB4535SSQG	SET OF 45MM SQ x 3.1/2" U-BOLTS c/w NUTS, WASHERS, FISHPLATES & AXLE PADS
UB4545SSQG	SET OF 45MM SQ x 4.1/2" U-BOLTS c/w NUTS, WASHERS, FISHPLATES & AXLE PADS
UB455SSQG	SET OF 45MM SQ x 5" U-BOLTS c/w NUTS, WASHERS, FISHPLATES & AXLE PADS
UB4555SSQG	SET OF 45MM SQ x 5.1/2" U-BOLTS c/w NUTS, WASHERS, FISHPLATES & AXLE PADS
UB5045SSQG	SET OF 50MM SQ x 4.1/2" U-BOLTS c/w NUTS, WASHERS, FISHPLATES & AXLE PADS
UB505SSQG	SET OF 50MM SQ x 5" U-BOLTS c/w NUTS, WASHERS, FISHPLATES & AXLE PADS
UB506SSQG	SET OF 50MM SQ x 6" U-BOLTS c/w NUTS, WASHERS, FISHPLATES & AXLE PADS

**SET OF ROUND GALVANISED
 U-BOLT c/w NUTS, WASHERS,
 FISHPLATES & AXLE PADS**

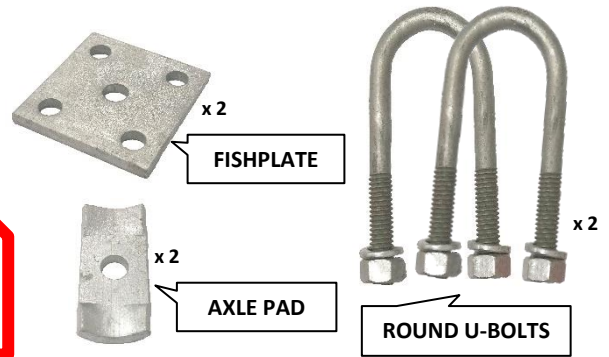

PART NO.	DESCRIPTION
UB3935SRDG	SET OF 39MM SQ x 3.1/2" U-BOLTS c/w NUTS, WASHERS, FISHPLATES & AXLE PADS
UB3945SRDG	SET OF 39MM SQ x 4.1/2" U-BOLTS c/w NUTS, WASHERS, FISHPLATES & AXLE PADS
UB395SRDG	SET OF 39MM SQ x 5" U-BOLTS c/w NUTS, WASHERS, FISHPLATES & AXLE PADS
UB3955SRDG	SET OF 39MM SQ x 5.1/2" U-BOLTS c/w NUTS, WASHERS, FISHPLATES & AXLE PADS
UB4535SRDG	SET OF 45MM SQ x 3.1/2" U-BOLTS c/w NUTS, WASHERS, FISHPLATES & AXLE PADS
UB455SRDG	SET OF 45MM SQ x 5" U-BOLTS c/w NUTS, WASHERS, FISHPLATES & AXLE PADS
UB4555SRDG	SET OF 45MM SQ x 5.1/2" U-BOLTS c/w NUTS, WASHERS, FISHPLATES & AXLE PADS
UB5045SRDG	SET OF 50MM SQ x 4.1/2" U-BOLTS c/w NUTS, WASHERS, FISHPLATES & AXLE PADS



FISHPLATE

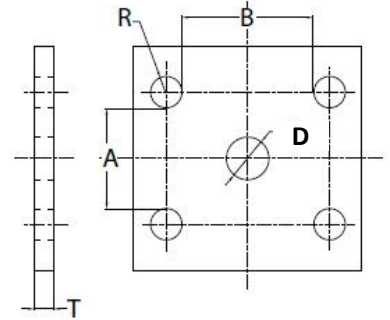

FISH PLATES (PUNCHED HOLE)

PART NO.	DESCRIPTION	SURFACE FINISH	A(MM)	B(MM)	D(MM)	T(MM)
FP3945	FISH PLATE	BLACK	39	45	16	8
FP3960	FISH PLATE	BLACK	39	60	16	7
FP4560	FISH PLATE	BLACK	45	60	21	8
FP5045	FISH PLATE	BLACK	50	45	17	8
FP5060	FISH PLATE	BLACK	50	60	16	8
FP3945G	FISH PLATE	GALV	39	45	15	7
FP5045G	FISH PLATE	GALV	50	45	19	8

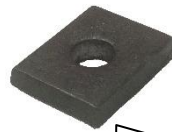

AXLE PAD

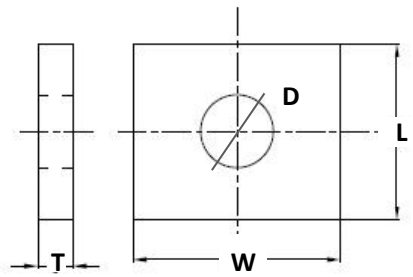

AXLE PADS

PART NO.	DESCRIPTION	SURFACE FINISH	W(MM)	L(MM)	D(MM)	T(MM)
AP1	AXLE PAD	BLACK	40	85	15	7
1146/1	FLAT AXLE PAD	BLACK	45	75	20	7
AP1G	AXLE PAD	GALV	40	85	15	7



STEEL BUSH

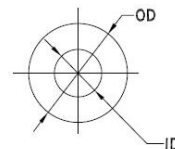

STEEL BUSHES

PART NO.	DESCRIPTION	SURFACE FINISH	OD	ID	L(MM)
9032	STEEL BUSH	BLACK	3/4"	1"	64MM
9046	STEEL BUSH	BLACK	1.1/4"	1"	64MM
SB134	STEEL BUSH	BLACK	3/4"	1"	60MM
IES1057/5	STEEL BUSH (SUIT R/R)	BLACK	5/8"	1.1/4"	60MM
9034	STEEL BUSH	BLACK	7/8"	1.1/8"	64MM
9044	STEEL BUSH	BLACK	1.3/8"	1.1/8"	64MM
SB3458	STEEL BUSH	BLACK	5/8"	3/4"	45MM
SB34916	STEEL BUSH	BLACK	9/16"	3/4"	45MM
SB7834	STEEL BUSH	BLACK	7/8"	3/4"	45MM
SB783460	STEEL BUSH	BLACK	7/8"	3/4"	60MM
SB785860	STEEL BUSH	BLACK	7/8"	5/8"	60MM
SB78916	STEEL BUSH	BLACK	7/8"	9/16"	45MM



NYLON BUSH

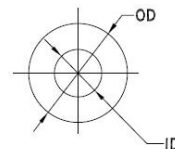
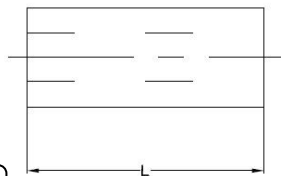

NYLON BUSHES

PART NO.	DESCRIPTION	SURFACE FINISH	OD	ID	L(MM)
NB1	NYLON BUSH	BLACK	3/4"	1/2"	45MM
NB2	NYLON BUSH	BLACK	7/8"	1/2"	45MM
NB12B	NYLON BUSH	BLACK	7/8"	1/2"	45MM
IES1057/2	NYLON BUSH (SUIT R/R)	BLACK	5/8"	1.1/4"	60MM
NB34916	NYLON BUSH	BLACK	9/16"	3/4"	45MM
NB58B	NYLON BUSH	BLACK	7/8"	5/8"	57MM
NB785860	NYLON BUSH	BLACK	7/8"	5/8"	60MM
NB78916	NYLON BUSH	BLACK	9/16"	7/8"	45MM



NYLON BUSH



STEEL BUSH

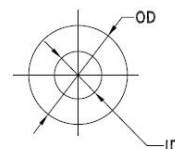

NYLON BUSHES

PART NO.	DESCRIPTION	SURFACE FINISH	OD	ID	L(MM)
NB1PK2	PACK OF 2 NYLON BUSH	BLACK	3/4"	1/2"	45MM
NB1PK4	PACK OF 4 NYLON BUSH	BLACK	3/4"	1/2"	45MM
NB2PK2	PACK OF 2 NYLON BUSH	BLACK	7/8"	1/2"	45MM
NB2PK4	PACK OF 4 NYLON BUSH	BLACK	7/8"	1/2"	45MM
IES1057/2PK2	PACK OF 2 NYLON BUSH (SUIT R/R)	BLACK	5/8"	1.1/4"	60MM
IES1057/2PK	PACK OF 4 NYLON BUSH (SUIT R/R)	BLACK	5/8"	1.1/4"	60MM
NB34916PK2	PACK OF 2 NYLON BUSH	BLACK	9/16"	3/4"	45MM
NB34916PK4	PACK OF 4 NYLON BUSH	BLACK	9/16"	3/4"	45MM
NB785860PK2	PACK OF 2 NYLON BUSH	BLACK	7/8"	5/8"	60MM
NB785860PK4	PACK OF 4 NYLON BUSH	BLACK	7/8"	5/8"	60MM
NB78916PK2	PACK OF 2 NYLON BUSH	BLACK	9/16"	7/8"	45MM
NB78916PK4	PACK OF 4 NYLON BUSH	BLACK	9/16"	7/8"	45MM

STEEL BUSHES

PART NO.	DESCRIPTION	SURFACE FINISH	OD	ID	L(MM)
576301PK2	PACK OF 2 STEEL BUSH (SUIT R/R)	BLACK	5/8"	1.1/4"	60MM
576301PK4	PACK OF 4 STEEL BUSH (SUIT R/R)	BLACK	5/8"	1.1/4"	60MM



NYLON BUSHES c/w FRONT BOLT



PART NO.	DESCRIPTION
NB3412FB/2	PACK OF 2 – 3/4" NYLON BUSHES & 1/2" F/BOLTS
NB3412FB/4	PACK OF 4 – 3/4" NYLON BUSHES & 1/2" F/BOLTS
NBP7812FB/2	PACK OF 2 – 7/8" NYLON BUSHES & 1/2" F/BOLTS
NBP7812FB/4	PACK OF 4 – 7/8" NYLON BUSHES & 1/2" F/BOLTS

NYLON BUSHES OR STEEL c/w GREASER PINS



PART NO.	DESCRIPTION
NBP58DP/4	PACK OF 4 – NYLON BUSHES 7/8 x 5/8 x 60MM & 5/8" G/PINS
SBP58GP/4	PACK OF 4 – STEEL BUSHES & 5/8" G/PINS
SBP58RGP/4	PACK OF 4 – STEEL ROLLER BUSHES & 5/8" G/PINS

NYLON BUSHES c/w DRY PINS



PART NO.	DESCRIPTION
NBP58RDP/4	PACK OF 4 – NYLON ROLLER BUSHES & 5/8" DRY PINS
NBP7858DP/4	PACK OF 4 – 7/8" NYLON BUSHES & 5/8" DRY PINS

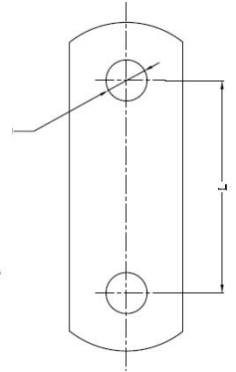

SHACKLE PLATES

PART NO.	DESCRIPTION	SURFACE FINISH	D	L(MM)
SP12	SHACKLE PLATE	BLACK	1/2"	65MM
SP58	SHACKLE PLATE	BLACK	5/8"	66MM
SP916	SHACKLE PLATE	BLACK	9/16"	66MM

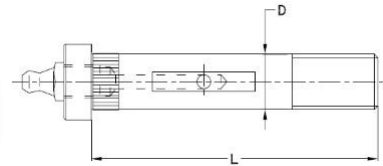

SHACKLE PIN c/w NYLON NUT

PART NO.	DESCRIPTION	SURFACE FINISH	D	L
SP58334	SHACKLE PIN & NYLON NUT	BLACK	5/8"	3.3/4"
701160	SHACKLE PIN & NYLON NUT	BLACK	5/8"	4"
SP9163	SHACKLE PIN & NYLON NUT	BLACK	9/16"	3"
701150	SHACKLE PIN & NYLON NUT	BLACK	9/16"	3.1/2"

ROCKER ARM

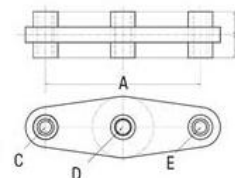

PART NO.	DESCRIPTION	SURFACE FINISH	A	C	D	E
XAR50	ROCKER ARM	BLACK	155MM	23MM	17MM	23MM

GREASER PIN c/w NYLON NUT

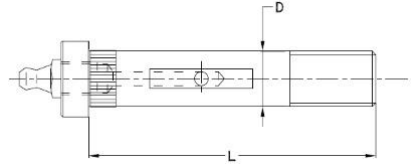

PART NO.	DESCRIPTION	SURFACE FINISH	D	L
GP34312	GREASER PIN & NYLON NUT	BLACK	3/4"	3.1/2
GP34334	GREASER PIN & NYLON NUT	BLACK	3/4"	3.3/4"
GP344	GREASER PIN & NYLON NUT	BLACK	3/4"	4"
GP34412	GREASER PIN & NYLON NUT	BLACK	3/4"	4.1/2"
701142	GREASER PIN & NYLON NUT	BLACK	5/8"	3.1/2"
701162	GREASER PIN & NYLON NUT	BLACK	5/8"	4"
GP58314	GREASER PIN & NYLON NUT	BLACK	5/8"	3.1/4"
GP58412	GREASER PIN & NYLON NUT	BLACK	5/8"	4.1/2"
701140	GREASER PIN & NYLON NUT	BLACK	9/16"	3.1/2"
GP916314	GREASER PIN & NYLON NUT	BLACK	9/16"	3.1/4"
GP916334	GREASER PIN & NYLON NUT	BLACK	9/16"	3.3/4"
GP9164	GREASER PIN & NYLON NUT	BLACK	9/16"	4"

GREASE NIPPLE



PART NO.	DESCRIPTION
H29	GREASE NIPPLE

REAR HANGERS



RH45P

REAR SPRING
 HANGER
 (45MM PARABOLIC)



RH45PG

REAR SPRING
 HANGER GALV
 (45MM PARABOLIC)



SAT9060

REAR SPRING
 HANGER STD.
 EYE & EYE
 (45MM X 1/2")



RH45

REAR SPRING
 HANGER STD
 (45MM SLIPPER)



RH45G

REAR SPRING
 HANGER STD GALV
 (45MM SLIPPER)

LONG CENTRE HANGERS



LCH

LONG CENTRE
 HANGER [1/2"]



LCHG

GALV. LONG CENTRE
 HANGER [1/2"]

FRONT HANGERS



FH4512

FRONT SPRING
 HANGER STD
 [1/2" X 45MM]



FH4512G

FRONT SPRING
 HANGER GALV STD
 [1/2" X 45MM]

Part Number	Description		
DC1	1.3/4" Grease Cap Outer Diameter: 1.3/4" Height: 30.2mm Suit: Standard & Heavy Duty Finishing: Galv		
DC2	2" Grease Cap Outer Diameter: 2" Height: 30mm Suit: Dexter Finishing: Zinc		
DC216	2.1/16" Grease Cap Outer Diameter: 2.1/16" Height: 35mm Suit: Old "C" Type Knock In Finishing: Zinc		
DC214	2.1/4" Grease Cap Outer Diameter: 2.1/4" Height: 37mm Finishing: Zinc		
DC59	59mm Grease Cap Outer Diameter: 59mm Height: 34mm Suit: Simplicity Finishing: Zinc		
DC62	62mm Grease Cap Outer Diameter: 62mm Height: 35mm Suit: Dexter Finishing: Zinc		

Part Number	Description		
GC25	<p>2.1/2" Grease Cap Outer Diameter: 2.1/2" Height: 37mm Suit: 2 Ton Finishing: Zinc</p>		
DC70	<p>70mm or 2.3/4" Grease Cap Outer Diameter: 70mm Height: 38.5mm Suit: Dexter Finishing: Zinc</p>		
GC3	<p>3" Grease Cap Outer Diameter: 3" Height: 46mm Suit: 3 Ton Finishing: Raw Material</p>		
DC80	<p>80mm Grease Cap Outer Diameter: 80mm Height: 39.5mm Suit: Agricultural Finishing: Zinc</p>		
DC90	<p>90mm Grease Cap Outer Diameter: 90mm Height: 43mm Suit: Agricultural Finishing: Zinc</p>		

Part No.	Description	Carrying Capacity	
39R8A	39mm Round x 8" Standard Duty Stub c/w 3/4" Nut, Washer & Pin Suit Bearing Combination LM67048/10 & LM11949/10 Grade of Steel: 1045	500KG	
39R9A	39mm Round x 9" Standard Duty Stub c/w 3/4" Nut, Washer & Pin Suit Bearing Combination LM67048/10 & LM11949/10 Grade of Steel: 1045	500KG	
39R10A	39mm Round x 10" Standard Duty Stub c/w 3/4" Nut, Washer & Pin Suit Bearing Combination LM67048/10 & LM11949/10 Grade of Steel: 1045	500KG	
39R12A	39mm Round x 12" Standard Duty Stub c/w 3/4" Nut, Washer & Pin Suit Bearing Combination LM67048/10 & LM11949/10 Grade of Steel: 1045	500KG	
40S8A	40mm Square x 8" Standard Duty Stub c/w 3/4" Nut, Washer & Pin Suit Bearing Combination LM67048/10 & LM11949/10 Grade of Steel: 1045	500KG	
40S9A	40mm Square x 9" Standard Duty Stub c/w 3/4" Nut, Washer & Pin Suit Bearing Combination LM67048/10 & LM11949/10 Grade of Steel: 1045	500KG	
40S10A	40mm Square x 10" Standard Duty Stub c/w 3/4" Nut, Washer & Pin Suit Bearing Combination LM67048/10 & LM11949/10 Grade of Steel: 1045	500KG	
40S12A	40mm Square x 12" Standard Duty Stub c/w 3/4" Nut, Washer & Pin Suit Bearing Combination LM67048/10 & LM11949/10 Grade of Steel: 1045	500KG	

Part No.	Description	Carrying Capacity	
45S8B	45mm Square x 8" Heavy Duty Stub c/w 7/8" Nut, Washer & Pin Suit Bearing Combination L68149/10 & LM12749/10 Grade of Steel: 1045	625KG	
45S9B	45mm Square x 9" Heavy Duty Stub c/w 7/8" Nut, Washer & Pin Suit Bearing Combination L68149/10 & LM12749/10 Grade of Steel: 1045	625KG	
45S10B	45mm Square x 10" Heavy Duty Stub c/w 7/8" Nut, Washer & Pin Suit Bearing Combination L68149/10 & LM12749/10 Grade of Steel: 1045	625KG	
45S12B	45mm Square x 12" Heavy Duty Stub c/w 7/8" Nut, Washer & Pin Suit Bearing Combination L68149/10 & LM12749/10 Grade of Steel: 1045	625KG	
50S8B	50mm Square x 8" Heavy Duty Stub c/w 7/8" Nut, Washer & Pin Suit Bearing Combination L68149/10 & LM12749/10 Grade of Steel: 1045	625KG	
50S9B	50mm Square x 9" Heavy Duty Stub c/w 7/8" Nut, Washer & Pin Suit Bearing Combination L68149/10 & LM12749/10 Grade of Steel: 1045	625KG	
50S10B	50mm Square x 10" Heavy Duty Stub c/w 7/8" Nut, Washer & Pin Suit Bearing Combination L68149/10 & LM12749/10 Grade of Steel: 1045	625KG	
50S12B	50mm Square x 12" Heavy Duty Stub c/w 7/8" Nut, Washer & Pin Suit Bearing Combination L68149/10 & LM12749/10 Grade of Steel: 1045	625KG	

Part No.	Description	Carrying Capacity	
50P12	50mm Square x 12" Parallel Stub c/w 1" Nut, Washer & Pin Suit Bearing Combination L68149/10 & L68149/10 Grade of Steel: 1045	800KG	
50E12	50mm Square x 16" 2 Ton Light Duty Stub c/w 1" Nut, Washer & Pin Suit Bearing Combination HR30210J & 15123/15245 Grade of Steel: 1045	1000KG	
63E16	63mm Square x 16" 2.25 Ton Stub c/w 1" Nut, Washer & Pin Suit Bearing Combination HR30210J & 15123/15245 Grade of Steel: 1045	1125KG	
63F16	63mm Square x 16" 3 Ton Stub c/w 1.1/4" Nut, Washer & Pin Suit Bearing Combination HR30210J & 29749/10 Grade of Steel: 1045	1500KG	

PLAIN

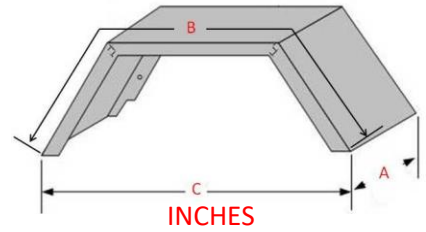
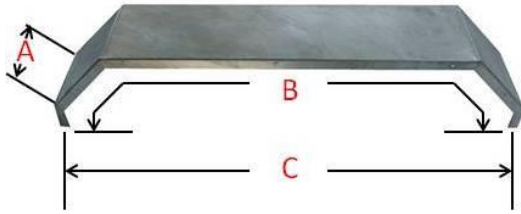

PART NO.	DESCRIPTION	A	B	C
MS2F0742	SINGLE 2-FOLD MINI MUDGUARD SUIT 10" WHEELS	7"	41"	28.5"



PART NO.	DESCRIPTION	A	B	C
MS2F1048	SINGLE 2-FOLD 14" MUDGUARD SUIT 14" & 15" ROAD WHEELS	10"	48"	34.5"



PART NO.	DESCRIPTION	A	B	C
MS4F12LC59	SINGLE 4-FOLD 16" MUDGUARD SUIT 15" & 16" OFF-ROAD WHEELS	12"	62.5"	38"



PART NO.	DESCRIPTION	A	B	C
MT2F1084	TANDEM 2-FOLD 14" MUDGUARD SUIT 14" TANDEM SLIPPER SPRINGS	10"	84"	69.25"



PART NO.	DESCRIPTION	A	B	C
MT4F1084	TANDEM 4-FOLD 14" MUDGUARD SUIT 14" TANDEM SLIPPER SPRINGS	10"	84"	61.5"



PART NO.	DESCRIPTION	A	B	C
MT4F1096	TANDEM 4-FOLD 14" MUDGUARD SUIT 14" TANDEM ROLLER ROCKER	10"	96"	71"



PART NO.	DESCRIPTION	A	B	C
MT4F1296	TANDEM 4-FOLD 16" MUDGUARD SUIT 16" TANDEM ROLLER ROCKER	12"	96"	72"



PART NO.	DESCRIPTION	A	B	C
MS2F1048G	SINGLE GALV 2-FOLD 14" MUDGUARD SUIT 14" & 15" ROAD WHEELS	10"	48"	35"



PART NO.	DESCRIPTION	A	B	C
MT2F1084G	TANDEM GALV 2-FOLD 14" MUDGUARD SUIT 14" TANDEM SLIPPER SPRINGS	10"	84"	69.75"



PART NO.	DESCRIPTION	A	B	C
MT2F1084Z	TANDEM ZINC 2-FOLD 14" MUDGUARD SUIT 14" TANDEM SLIPPER SPRINGS	10"	84.25"	70.25"

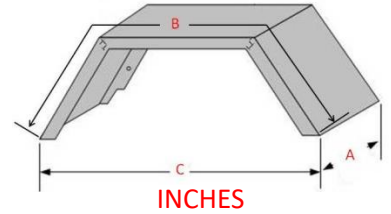
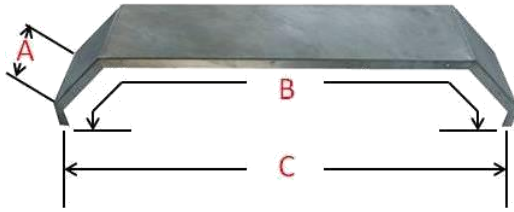

PART NO.	DESCRIPTION	A	B	C
MSCP4F9	SINGLE C/P 4-FOLD 14" MUDGUARD SUIT 14" ROAD WHEELS	9"	48"	33.75"



PART NO.	DESCRIPTION	A	B	C
MSCP4F11	SINGLE C/P 4-FOLD 16" MUDGUARD SUIT 15" & 16" OFF-ROAD WHEELS	11"	62.5"	39"



PART NO.	DESCRIPTION	A	B	C
MTCP4F984	TANDEM C/P 4-FOLD 14" MUDGUARD SUIT 14" TANDEM SLIPPER SPRINGS	9"	84"	60.75"



PART NO.	DESCRIPTION	A	B	C
MTCP4F991	TANDEM C/P 4-FOLD 14" MUDGUARD SUIT 14" TANDEM ROCKER	9"	91"	68.5"



PART NO.	DESCRIPTION	A	B	C
MTCP4F996	TANDEM C/P 4-FOLD 14" MUDGUARD SUIT 14" TANDEM ROLLER ROCKER	9"	96"	73"



PART NO.	DESCRIPTION	A	B	C
MTCP4F1191	TANDEM C/P 4-FOLD 16" MUDGUARD SUIT 16" TANDEM ROCKER	11"	91"	68.7"



PART NO.	DESCRIPTION	A	B	C
MTCP4F1196	TANDEM C/P 4-FOLD 16" MUDGUARD SUIT 16" TANDEM ROLLER ROCKER	11"	95.75"	72.75"

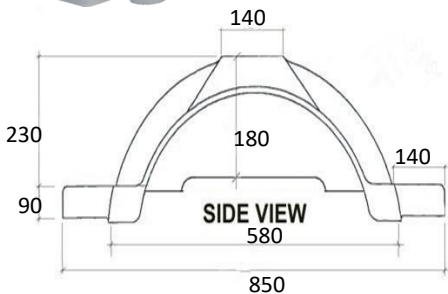

10" PLASTIC MUDGUARDS

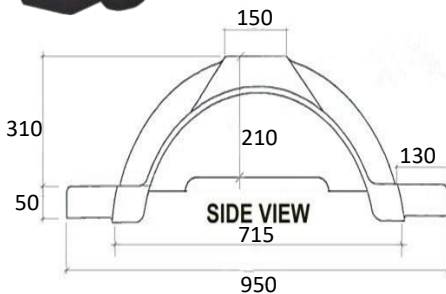

13" PLASTIC MUDGUARDS

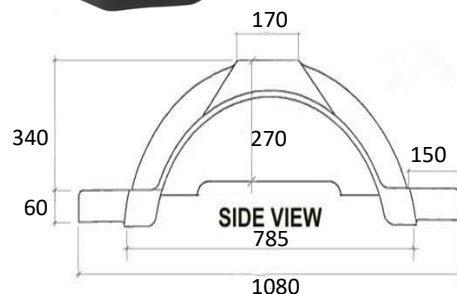

14" PLASTIC MUDGUARDS

PART NO.	DESCRIPTION	COLOUR
PMG10B PMG10S PMG10W	PAIR 10" PLASTIC MUDGUARDS	BLACK SILVER WHITE
PMG13B PMG13S PMG13W	PAIR 13" PLASTIC MUDGUARDS	BLACK SILVER WHITE
PMG14B PMG14S PMG14W	PAIR 14" PLASTIC MUDGUARDS	BLACK SILVER WHITE



PART NO.	DESCRIPTION
PMGBRAC	BRACKETS to suit PLASTIC MUDGUARDS

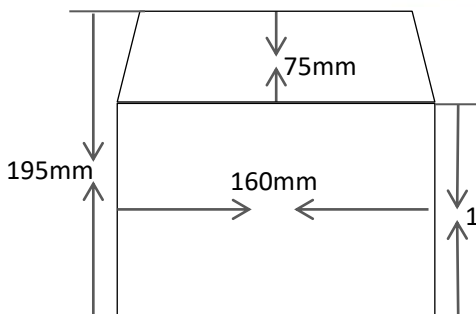

**MUDFLAP SUIT PLASTIC
 MUDGUARDS 10"**

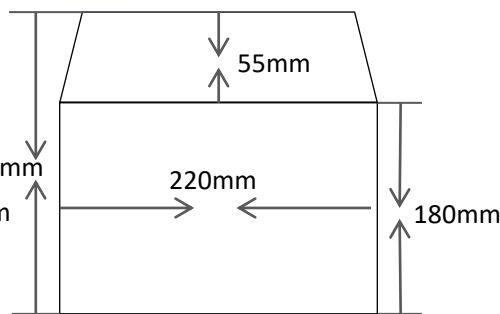

**MUDFLAP SUIT PLASTIC
 MUDGUARDS 13" & 14"**

DESCRIPTION	COLOUR
<p>MUDFLAP SUIT PLASTIC MUDGUARDS 10"</p>	<p>BLACK SILVER WHITE</p>
<p>MUDFLAP SUIT PLASTIC MUDGUARDS 13" & 14"</p>	<p>BLACK SILVER WHITE</p>

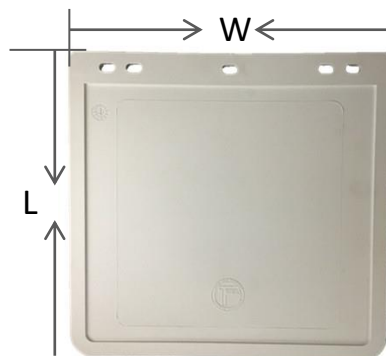
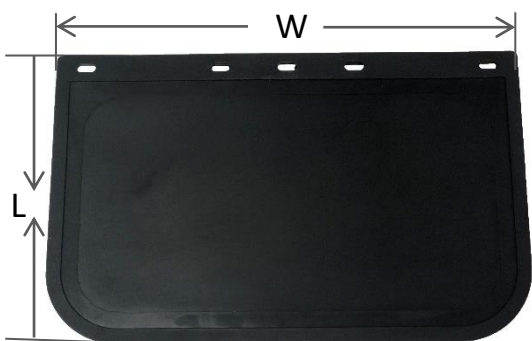

PART NO.	DESCRIPTION	COLOUR
MF82510B MF82510W	8.25"(W) x 10"(L) PLAIN MUDFLAP	BLACK WHITE
MF910B MF910W	9"(W) x 10"(L) PLAIN MUDFLAP	BLACK WHITE
MF912B MF912W	9"(W) x 12"(L) PLAIN MUDFLAP	BLACK WHITE
MF914B MF914W	9"(W) x 14"(L) PLAIN MUDFLAP	BLACK WHITE
MF1111B MF1111W	11"(W) x 11"(L) PLAIN MUDFLAP	BLACK WHITE
MF1114B MF1114W	11"(W) x 14"(L) PLAIN MUDFLAP	BLACK WHITE
MF1812B MF1812W	18"(W) x 12"(L) PLAIN MUDFLAP	BLACK WHITE
MF2214B MF2214W	22"(W) x 14"(L) PLAIN MUDFLAP	BLACK WHITE