

HANGER KIT

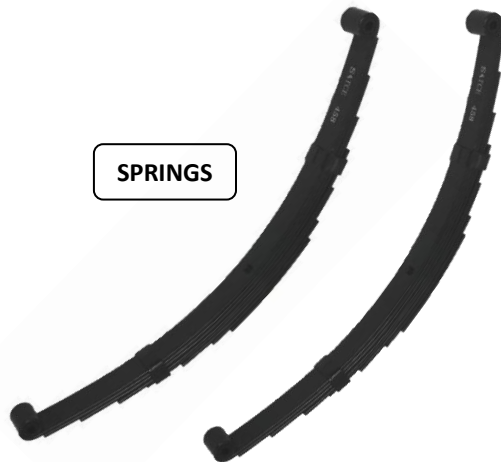

SPRINGS



1/2" AXLE FITTINGS

45MM EYE TO EYE SPRING SETS

PART NO.	DESCRIPTION	CARRYING CAPACITY	FINISH	A	B	C	D
SASE456S	SET SAT 6L x 45mm EYE to EYE SPRINGS	750KG	BLACK	716mm	145mm	367mm	722mm
SASE458S	SET SAT 8L x 45mm EYE to EYE SPRINGS	950KG					
SASE4510S	SET SAT 10L x 45mm EYE to EYE SPRINGS	1270KG					

PLEASE NOTE: SET OF SPRINGS INC. SPRINGS, HANGER KIT & 1/2" AXLE FITTINGS

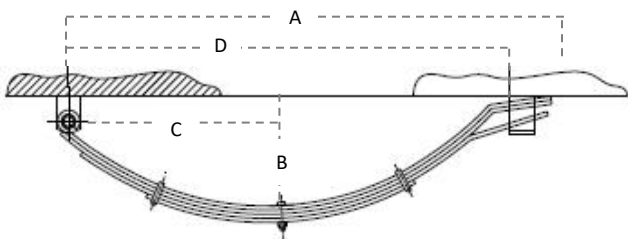

HANGER KIT

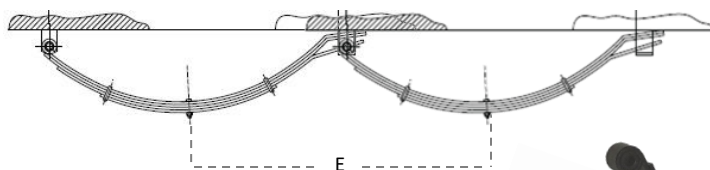

1/2" AXLE FITTINGS



SPRINGS

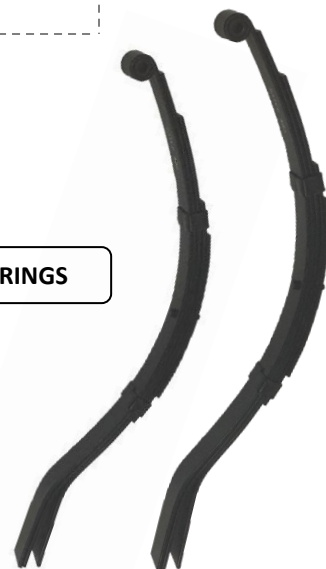

45MM BLACK SLIPPER SPRING SETS

PART NO.	DESCRIPTION	SPRING BUSH DIMENSIONS	CARRYING CAPACITY	A(mm)	B(mm)	C(mm)	D(mm)	E(mm)
SASS453S	SET SAT 3L x 45mm SLIPPER SPRING	7/8" x 1/2" x 45mm	500KG	765	155	330	700	725
SASS454S	SET SAT 4L x 45mm SLIPPER SPRING		700KG					
SASS455S	SET SAT 5L x 45mm SLIPPER SPRING		1000KG					
SASS456S	SET SAT 6L x 45mm SLIPPER SPRING		1120KG					
SASS457S	SET SAT 7L x 45mm SLIPPER SPRING		1270KG					
SASS458S	SET SAT 8L x 45mm SLIPPER SPRING		1375KG					
SASS459S	SET SAT 9L x 45mm SLIPPER SPRING		1500KG					

PLEASE NOTE: SET OF SPRINGS INC. SPRINGS, HANGER KIT & 1/2" AXLE FITTINGS

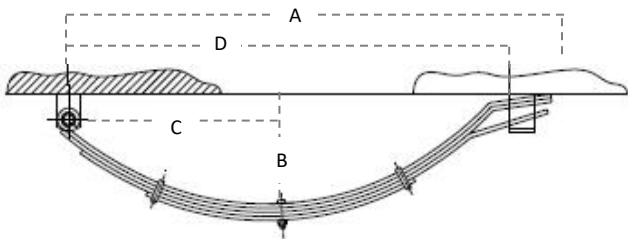

45MM BLACK SLIPPER SPRING ONLY

PART NO.	DESCRIPTION	SPRING BUSH DIMENSIONS	CARRYING CAPACITY	A(mm)	B(mm)	C(mm)	D(mm)
SASS453	SET SAT 3L x 45mm SLIPPER SPRING ONLY	7/8" x 1/2" x 45mm	250KG	765	155	330	700
SASS454	SET SAT 4L x 45mm SLIPPER SPRING		350KG				
SASS455	SET SAT 5L x 45mm SLIPPER SPRING ONLY		500KG				
SASS456	SET SAT 6L x 45mm SLIPPER SPRING ONLY		560KG				
SASS457	SET SAT 7L x 45mm SLIPPER SPRING ONLY		635KG				
SASS458	SET SAT 8L x 45mm SLIPPER SPRING ONLY		688KG				
SASS459	SET SAT 9L x 45mm SLIPPER SPRING ONLY		750KG				

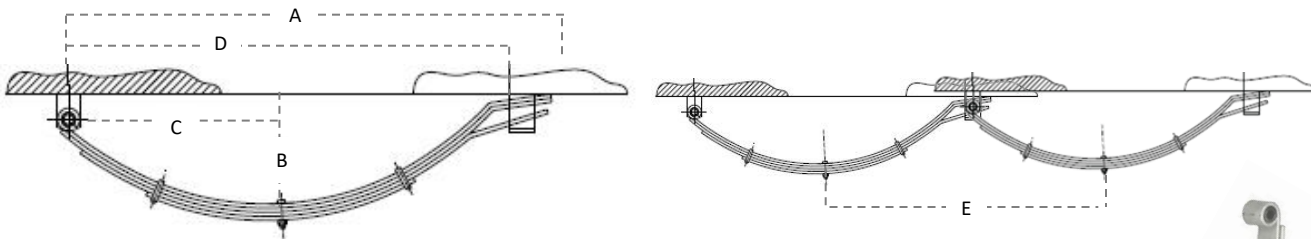

GALV HANGER KIT

GALV 1/2" AXLE FITTINGS

SPRINGS

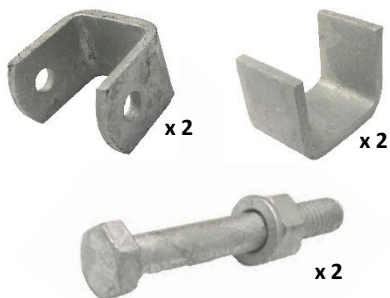

45MM DACROMET SLIPPER SPRING SETS

PART NO.	DESCRIPTION	SPRING BUSH DIMENSIONS	CARRYING CAPACITY	A(mm)	B(mm)	C(mm)	D(mm)	E(mm)
SASS453SG	SET SAT 3L x 45mm DAC SLIPPER SPRING	7/8" x 1/2" x 45mm	500KG	765	155	330	700	725
SASS454SG	SET SAT 4L x 45mm DAC SLIPPER SPRING		700KG					
SASS455SG	SET SAT 5L x 45mm DAC SLIPPER SPRING		1000KG					
SASS456SG	SET SAT 6L x 45mm DAC SLIPPER SPRING		1120KG					
SASS457SG	SET SAT 7L x 45mm DAC SLIPPER SPRING		1270KG					
SASS459SG	SET SAT 9L x 45mm DAC SLIPPER SPRING		1500KG					

PLEASE NOTE: SET OF SPRINGS INC. SPRINGS, GALV HANGER KIT & GALV 1/2" AXLE FITTINGS

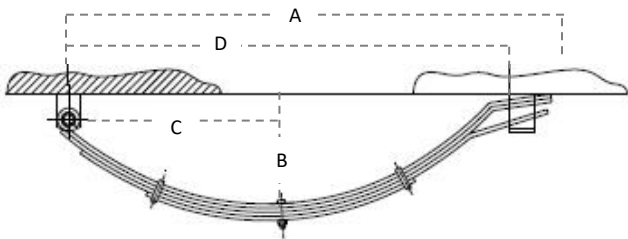

45MM DACROMET SLIPPER SPRING ONLY

PART NO.	DESCRIPTION	SPRING BUSH DIMENSIONS	CARRYING CAPACITY	A(mm)	B(mm)	C(mm)	D(mm)
SASS453G	SET SAT 3L x 45mm DAC SLIPPER SPRING ONLY	7/8" x 1/2" x 45mm	500KG	765	155	330	700
SASS454G	SET SAT 4L x 45mm DAC SLIPPER SPRING ONLY		700KG				
SASS455G	SET SAT 5L x 45mm DAC SLIPPER SPRING ONLY		1000KG				
SASS456G	SET SAT 6L x 45mm DAC SLIPPER SPRING ONLY		1120KG				
SASS457G	SET SAT 7L x 45mm DAC SLIPPER SPRING ONLY		1270KG				
SASS459G	SET SAT 9L x 45mm DAC SLIPPER SPRING ONLY		1500KG				

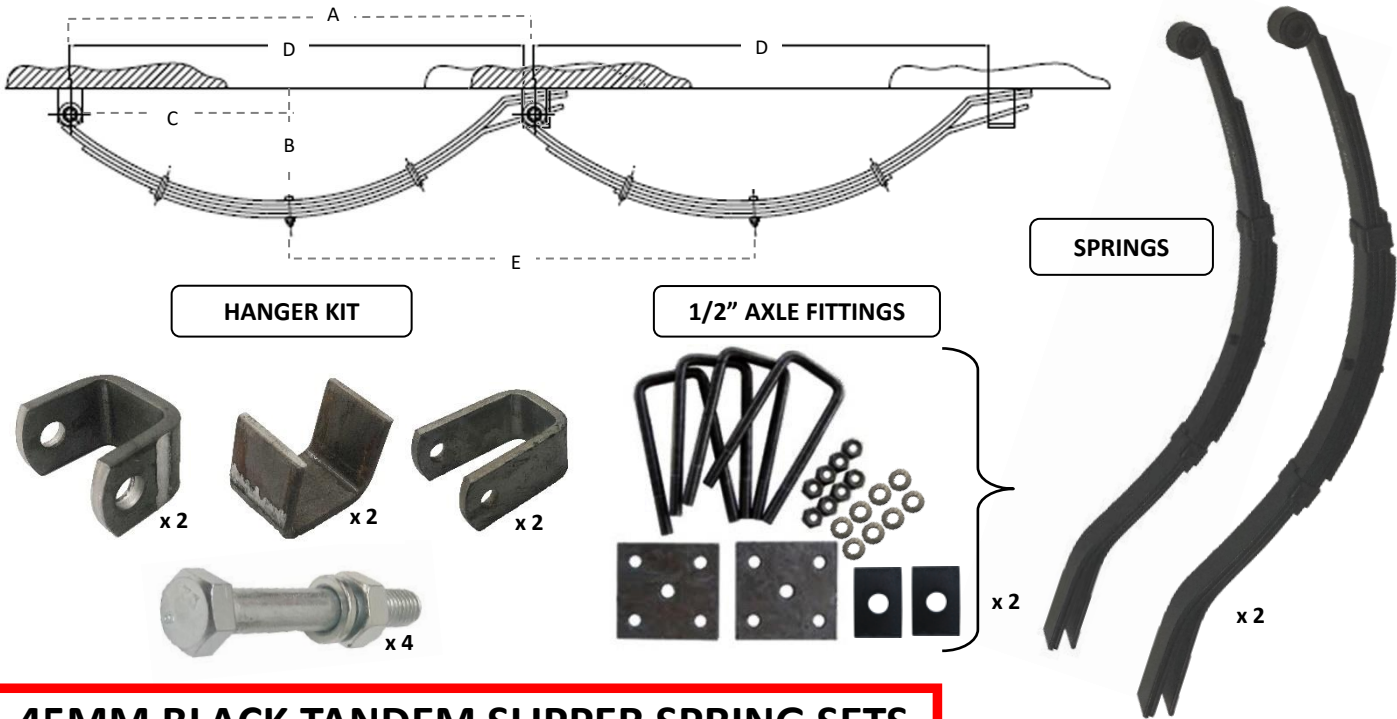

45MM BLACK TANDEM SLIPPER SPRING SETS

PART NO.	DESCRIPTION	SPRING BUSH DIMENSIONS	CARRYING CAPACITY	A(mm)	B(mm)	C(mm)	D(mm)	E(mm)
SASST453S	SET SAT 3L x 45mm TANDEM SLIPPER SPRING	7/8" x 1/2" x 45mm	1000KG	765	155	330	700	707
SASST454S	SET SAT 4L x 45mm TANDEM SLIPPER SPRING		1400KG					
SASST455S	SET SAT 5L x 45mm TANDEM SLIPPER SPRING		2000KG					
SASST456S	SET SAT 6L x 45mm TANDEM SLIPPER SPRING		2240KG					
SASST457S	SET SAT 7L x 45mm TANDEM SLIPPER SPRING		2540KG					
SASST458S	SET SAT 8L x 45mm TANDEM SLIPPER SPRING		2750KG					
SASST459S	SET SAT 9L x 45mm TANDEM SLIPPER SPRING		3000KG					

PLEASE NOTE: SET OF SPRINGS INC. SPRINGS, HANGER KIT & 1/2" AXLE FITTINGS

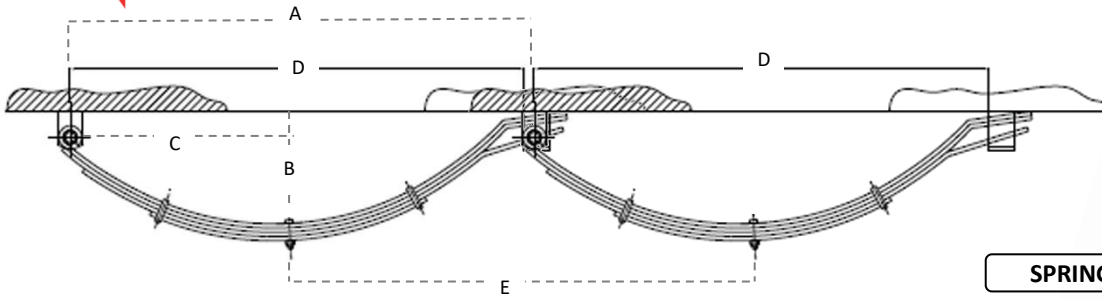

GALV HANGER KIT

GALV 1/2" AXLE FITTINGS

SPRINGS

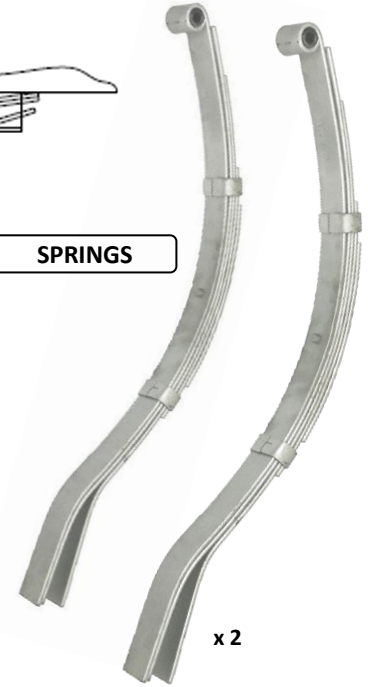
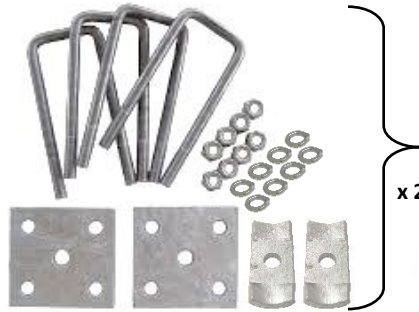
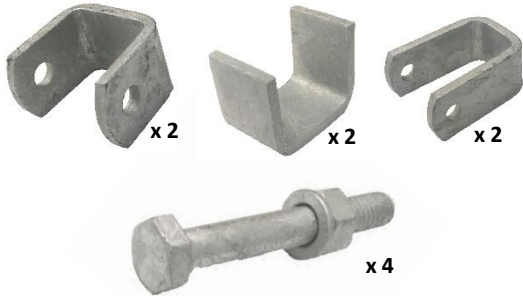

45MM DACROMET TANDEM SLIPPER SPRING SETS

PART NO.	DESCRIPTION	SPRING BUSH DIMENSIONS	CARRYING CAPACITY	A(mm)	B(mm)	C(mm)	D(mm)	E(mm)
SASST453SG	SET SAT 3L x 45mm DAC TANDEM SLIPPER SPRING	7/8" x 1/2" x 45mm	1000KG	765	155	330	700	707
SASST454SG	SET SAT 4L x 45mm DAC TANDEM SLIPPER SPRING		1400KG					
SASST455SG	SET SAT 5L x 45mm DAC TANDEM SLIPPER SPRING		2000KG					
SASST456SG	SET SAT 6L x 45mm DAC TANDEM SLIPPER SPRING		2240KG					
SASST457SG	SET SAT 7L x 45mm DAC TANDEM SLIPPER SPRING		2540KG					
SASST459SG	SET SAT 9L x 45mm DAC TANDEM SLIPPER SPRING		3000KG					

PLEASE NOTE: SET OF SPRINGS INC. SPRINGS, GALV HANGER KIT & GALV 1/2" AXLE FITTINGS

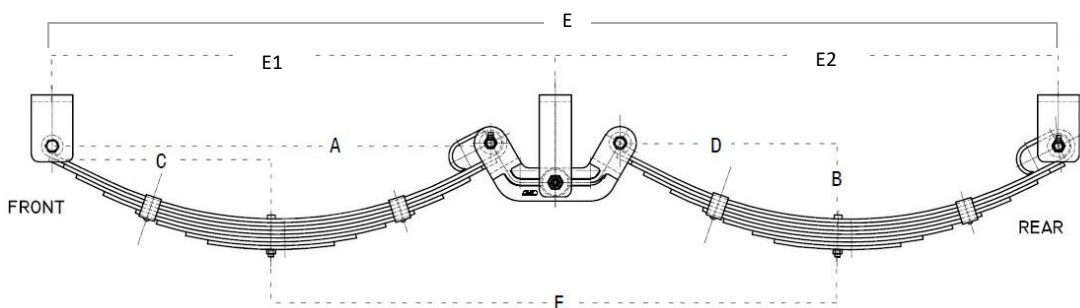

AXLE FITTING

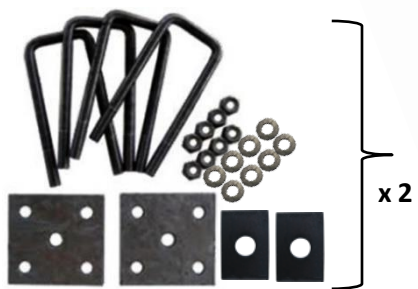

**60MM x 6MM & 7MM
TANDEM ROCKER ROLLER
SPRING SETS**

PART NO.	DESCRIPTION	CARRYING CAPACITY	A(mm)	B(mm)	C(mm)	D(mm)	E(mm)	E1=E2 (mm)	F(mm)
SASRR605-14S	SET SAT 5L x 60mm x 6mm TANDEM ROCKER ROLLER SPRING (14") *	2000KG	695	102	395	290	1584	795	795
SASRR606-14S	SET SAT 6L x 60mm x 6mm TANDEM ROCKER ROLLER SPRING (14") *	2500KG							
SASRR607-14S	SET SAT 7L x 60mm x 6mm TANDEM ROCKER ROLLER SPRING (14") *	3000KG							
SASRR608-14S	SET SAT 8L x 60mm x 6mm TANDEM ROCKER ROLLER SPRING (14") *	4000KG							
SASRR606-16S	SET SAT 6L x 60mm x 7mm TANDEM ROCKER ROLLER SPRING (16") *	2500KG	690	102	345	360	1584	795	920
SASRR607-16S	SET SAT 7L x 60mm x 7mm TANDEM ROCKER ROLLER SPRING (16") *	3000KG							
SASRR608-16S	SET SAT 8L x 60mm x 7mm TANDEM ROCKER ROLLER SPRING (16") *	4000KG							
SASRR609-16S	SET SAT 9L x 60mm x 7mm TANDEM ROCKER ROLLER SPRING (16") *	4500KG							

PLEASE NOTE: SET OF SPRINGS INC. SPRINGS c/w HANGER & 1/2" AXLE FITTINGS

PLEASE NOTE: SET OF 8L & 9L (16") TDM R/ROLLER SPRINGS c/w HANGER & 5/8" AXLE FITTINGS