

When rigid stability is required the AL-KO range of stands fits the bill. Available in varying heights and also in weld on swivel bracket versions.

These steady stands are ideal for fixed location stabilizing of trailers and plant equipment.

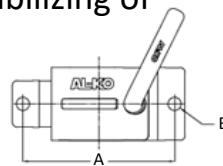
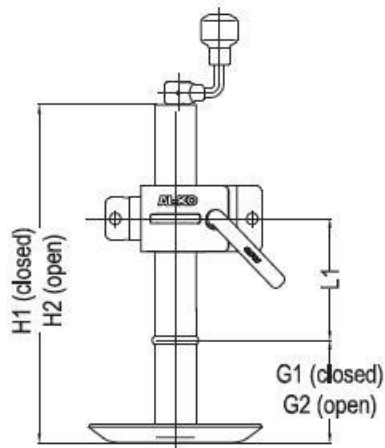

AS14

Part No.	Outer Tube mm <sup>2</sup>	Tube Mount Fitted	Weight KG	Load Capacity KG	Surface Finish	H1	H2	G1	G2
AS14	48.0RD	N/A	4.5	400	Zinc	375	625	70	320



AS20

Part No.	Outer Tube mm <sup>2</sup>	Tube Mount Fitted	Weight KG	Load Capacity KG	Surface Finish	H1	H2	G1	G2
AS20	48.0RD	N/A	5.0	400	Zinc	515	765	160	410



AS27

Part No.	Outer Tube mm <sup>2</sup>	Tube Mount Fitted	Weight KG	Load Capacity KG	Surface Finish	H1	H2	G1	G2
AS27	48.0RD	N/A	6.0	400	Zinc	695	945	360	610



629000

Part No.	Outer Tube mm <sup>2</sup>	Tube Mount Fitted	Weight KG	Load Capacity KG	Surface Finish	A	B
629000	48.0RD	N/A	N/A	N/A	Zinc	150	13

The AL-KO Landing Leg is the latest addition to AL-KO's extensive range of quality trailer components. Ideal for stabilising plant trailers, camper trailers, 5 wheeler caravans and agricultural equipment, the AL-KO Landing Leg is a necessary inclusion to the toolkit of the commercial contractor, farmer and camping enthusiast alike. All bases are covered with the AL-KO range of Landing Legs, with static loads ranging from 1,300 to 4,500kg. An AL-KO Landing Leg can also be fitted to another brands existing mounting kit. The AL-KO Landing Leg is your ideal choice when looking to safely and efficiently stabilise your trailer, camper, 5 wheeler caravan or agricultural machinery.

Part No.	Outer Tube mm <sup>2</sup>	Tube Mount Fitted	Weight KG	Load Capacity KG	Surface Finish	A1	A2	B	C	D
622057	57.5RD	Yes	6.7	1300	Zinc	550	900	400	167	118
622057L	57.5RD	Yes	9.1	1300	Zinc	1060	1440	910	167	118
622070	70.0SQ	No	11.8	1500	Zinc	595	1275	-	167	118
622070WTM	70.0SQ	Yes	12.3	1500	Zinc	595	1275	-	167	118
622071	70.0SQ	No	9.9	2000	Zinc	580	940	-	167	118
622071WTM	70.0SQ	Yes	10.4	2000	Zinc	580	940	430	167	118
622110	110 SQ	No	32.9	4500	Zinc	690	1275	-	326	250
622000	Chassis Mount & Tube Bracket Kit				Zinc	-				

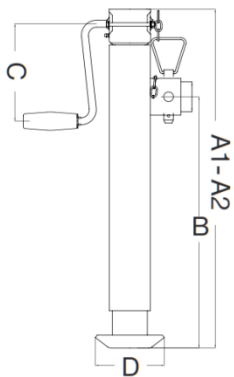

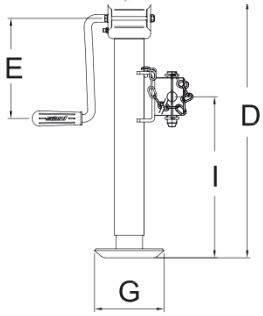

**LT2103**  
51mm RD Side Wind Z/P Tube  
Mount Stand no drop leg



**LT3153**  
57mm RD Side Wind Z/P Tube  
Mount Stand no drop leg

Part No.	Outer Tube mm <sup>2</sup>	Weight KG	Load Capacity KG	D	E	G	I
LT3153	57 RD	7.1	1300	560	168	120x165	405

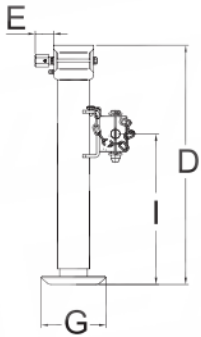

**LR3152/19**  
57mm RD Z/P Tube Mount Stand  
c/w Handle no drop leg

Part No.	Outer Tube mm <sup>2</sup>	Weight KG	Load Capacity KG	D mm	E mm	G mm	I mm
LR3152/19	57 RD	7.1	1300	560	19x30	120x165	406

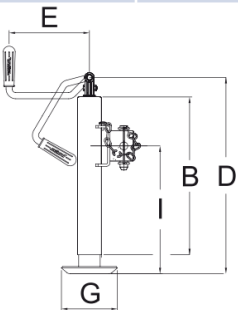

**ST3154**  
57mm RD Top Wind Z/P Tube  
Mount Stand no drop leg

Part No.	Outer Tube mm <sup>2</sup>	Weight KG	Load Capacity KG	B	D	E	G	I
ST3154	57 RD	6.4	1300	455	535	168	120x165	390

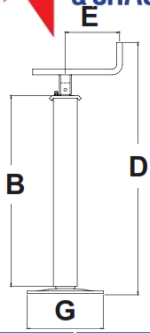

**P560**  
70mm SQ Top Wind Red  
Ag Stand no drop leg

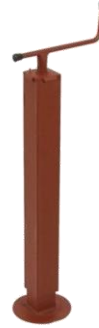

**P575**  
80mm SQ Top Wind Red  
Ag Stand no drop leg

Part No.	Outer Tube mm <sup>2</sup>	Weight KG	Load Capacity KG	B	D	E	G
P560	70 SQ	8.2	1000	500	670	185	160
P575	80 SQ	11	1200	500	670	185	200

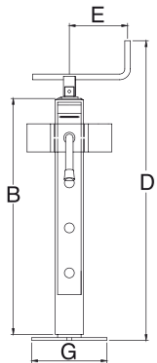

**PE595**  
70mm SQ Top Wind Red Ag  
Stand & Bracket no drop leg

Part No.	Outer Tube mm <sup>2</sup>	Weight KG	Load Capacity KG	B	D	E	G
PE595	70 SQ	11.5	1000	500	670	185	160

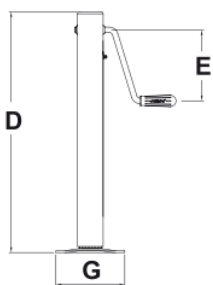

**DG590**  
70mm SQ Side Wind Red Stand &  
Bracket (no Drop Leg) 1500kg

Part No.	Outer Tube mm <sup>2</sup>	Weight KG	Load Capacity KG	D	E	G
DG590	70 SQ	8.4	1500	530	175	120x165

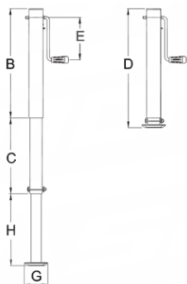

**DG600/3SFW**  
70mm SQ Side Wind Zinc Plated  
Stand c/w drop leg (3 stage wind)

Part No.	Outer Tube mm <sup>2</sup>	Weight KG	Load Capacity KG	B	C	D	E	G	H
DG600/3SFW	70 SQ	11.9	2000	340	300	635	210	120x165	340

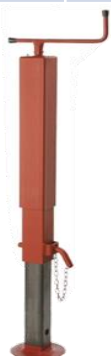
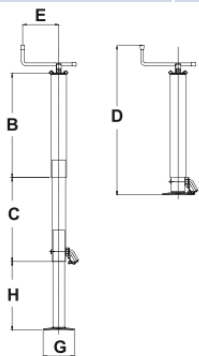

**P575/3SF**  
80mm SQ Top Wind Red Ag Stand  
c/w Drop Leg

Part No.	Outer Tube mm <sup>2</sup>	Weight KG	Load Capacity KG	B	C	D	E	G	H
P575/3SF	80 SQ	16.7	1000	530	360	790	185	160	320

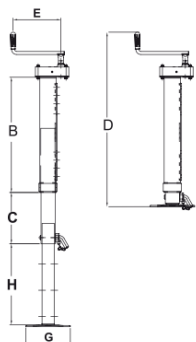

**PR675/3SF1**  
80mm SQ Geared Top Wind Red  
Ag Stand & Bracket c/w Drop Leg

Part No.	Outer Tube mm <sup>2</sup>	Weight KG	Load Capacity KG	B	C	D	E	G	H
PR675/3SF1	80 SQ	20	2500	570	300	855	235	220	390

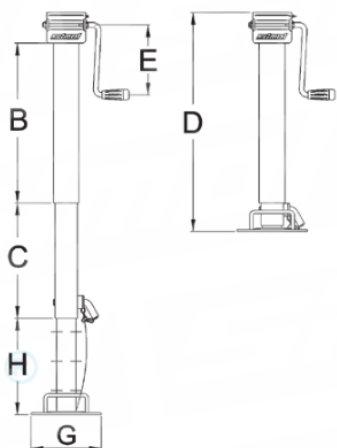

**DG590/3SF**  
70mm Square Side Wind  
Z/Plated Stand & Bracket  
(c/w Drop Leg)



**DG706/3SFW**  
80mm Squ. Side Wind Red Ag  
Stand (c/w drop leg) (3 speed)

**DG706/3SF**  
80mm Square Side Wind Red  
Stand (c/w Drop Leg)



**K450**  
110mm Square 4.5 Ton  
Drop Leg Parking Jack

Part No.	Outer Tube mm <sup>2</sup>	Weight KG	Load Capacity KG	B	C	D	E	G	H
DG590/3SF	70 SQ	12.5	1500	460	420	595	160	120x165	348
DG706/3SF	80 SQ	21	2500	500	290	685	225	220	276
DG706/3SFW	80 SQ	21	2500	500	290	685	225	220	276
K450	110 SQ	32	4500	600	310	700	325	250	300

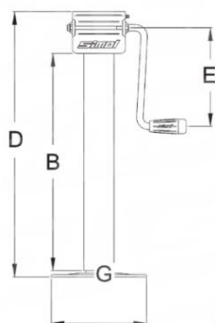

**DG706W**  
80mm SQ Side Wind Red Ag  
Stand no drop leg (2 stage wind)

Part No.	Outer Tube mm <sup>2</sup>	Weight KG	Load Capacity KG	B	D	E	G
DG706W	80 SQ	13.4	4000	500	620	225	220

Part No.	Description	Suit	
MS650	JACK HANDLE	LR3152/19	
F5	FLAT MOUNT PLATE	SQUARE STANDS	
LT/ST0141	WELD ON TUBE	LT2103 LT3153 LR3152/19 ST3154	
LT/ST0151	BOLT ON OR WELD ON TUBE	LR3152/19	
LF/SF0121	WELD ON PLATE	LF3151 SF3152	
040.02	MOUNT PLATE	H1140P	
SIM.DG706/ MAN	PVC HANDLE	PR675/3SF1; PE600; PE595; P560; P575; DG590; P575/3SF; DG706W; DG706/3SF; DG706/3SFW	