

Side Elevation

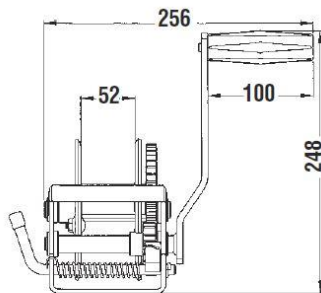

Front Elevation

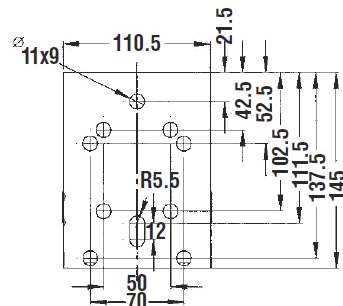

Boltdown Specs.

F10212 3:1 L/DUTY WINCH (SMALL) c/w CABLE



TYPE OF RATCHET	APPLICATION	RATED CAPACITY	CABLE BREAKING STRAIN	CABLE (AS SUPPLIED)	MAX. EFFORT ON HANDLE @ RATED LOAD
LEVER ACTION	PULLING	500KG (4900N)	865KG	6m X 4mm	20KG

F10202 3:1 L/DUTY WINCH (SMALL) c/w WEBBING



TYPE OF RATCHET	APPLICATION	RATED CAPACITY	MASS (NO WEBBING)	WEBBING (AS SUPPLIED)	MAX. EFFORT ON HANDLE @ RATED LOAD
LEVER ACTION	PULLING	500KG (4900N)	3.81KG	6m	20KG

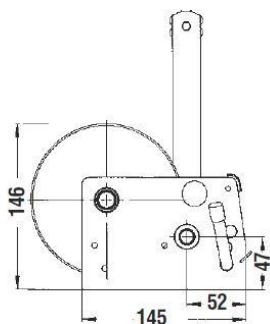

Side Elevation

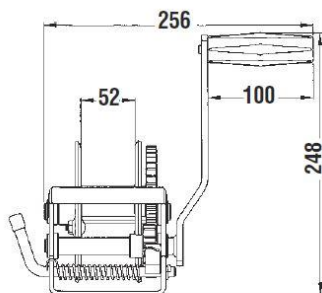

Front Elevation

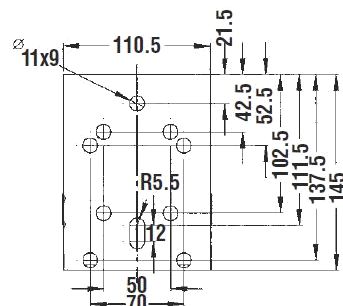

Boltdown Specs.

F10214

5:1 MED/DUTY WINCH

c/w CABLE



TYPE OF RATCHET	APPLICATION	RATED CAPACITY	CABLE BREAKING STRAIN	CABLE (AS SUPPLIED)	MAX. EFFORT ON HANDLE @ RATED LOAD
LEVER ACTION	PULLING	700KG (6860N)	865KG	6m X 4mm	25KG

F10204

5:1 MED/DUTY WINCH

c/w WEBBING



TYPE OF RATCHET	APPLICATION	RATED CAPACITY	MASS (NO WEBBING)	WEBBING (AS SUPPLIED)	MAX. EFFORT ON HANDLE @ RATED LOAD
LEVER ACTION	PULLING	700KG (6860N)	4.07KG	6m	25KG

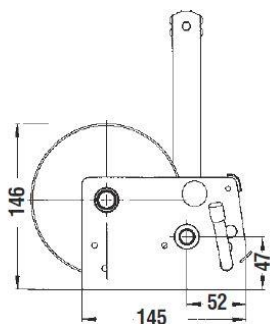

Side Elevation

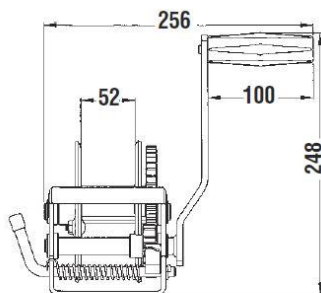

Front Elevation

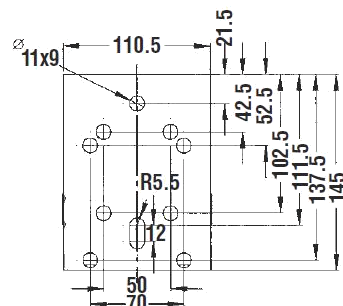

Boltdown Specs.

F10217

5:1 1:1 H/DUTY WINCH

c/w CABLE

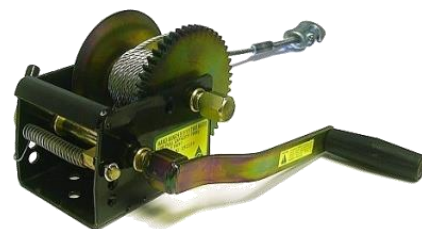

TYPE OF RATCHET	APPLICATION	RATED CAPACITY	CABLE BREAKING STRAIN	CABLE (AS SUPPLIED)	MAX. EFFORT ON HANDLE @ RATED LOAD
LEVER ACTION	PULLING	700KG (6860N)	1855KG	6m X 5mm	25KG

F10206

5:1 1:1 H/DUTY WINCH

c/w WEBBING



TYPE OF RATCHET	APPLICATION	RATED CAPACITY	MASS (NO WEBBING)	WEBBING (AS SUPPLIED)	MAX. EFFORT ON HANDLE @ RATED LOAD
LEVER ACTION	PULLING	700KG (6860N)	4.07KG	6m	25KG

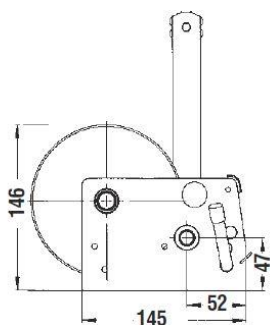

Side Elevation

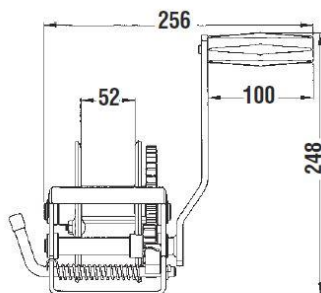

Front Elevation

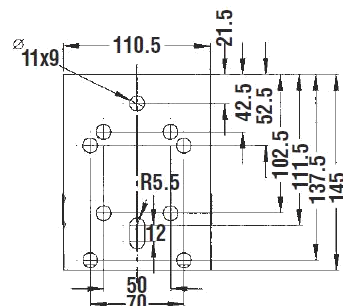

Boltdown Specs.

F10950 10:1 5:1 1:1 EX. H/DUTY WINCH c/w CABLE

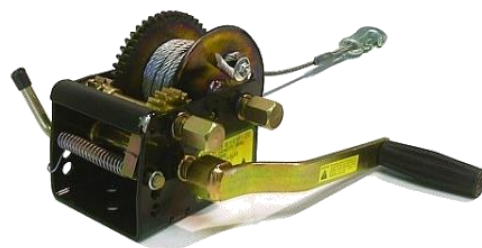

TYPE OF RATCHET	APPLICATION	RATED CAPACITY	CABLE BREAKING STRAIN	CABLE (AS SUPPLIED)	MAX. EFFORT ON HANDLE @ RATED LOAD
LEVER ACTION	PULLING	800KG – 1000KG	1855KG	7.5m X 5mm	18KG

F10952 10:1 5:1 1:1 EX. H/DUTY WINCH c/w WEBBING

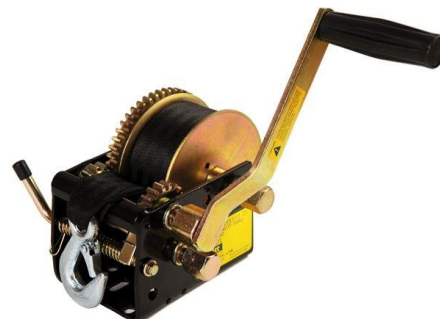

TYPE OF RATCHET	APPLICATION	RATED CAPACITY	MASS (NO WEBBING)	WEBBING (AS SUPPLIED)	MAX. EFFORT ON HANDLE @ RATED LOAD
LEVER ACTION	PULLING	800KG – 1000KG	4.99KG	7.5m	18KG

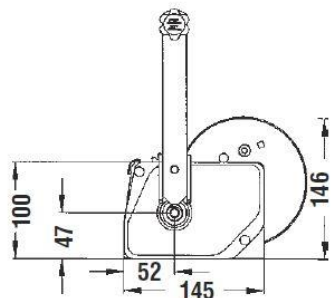

Side Elevation

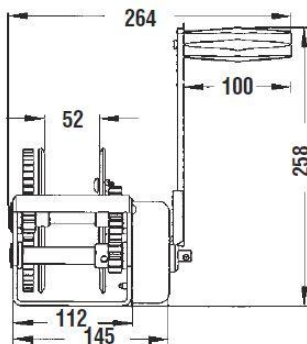

Front Elevation

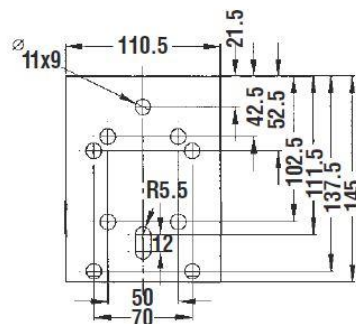

Boltdown Specs.

F18230

5:1 (300KG) BRAKE WINCH c/w CABLE



TYPE OF BRAKE	APPLICATION	RATED CAPACITY	CABLE BREAKING STRAIN	CABLE (AS SUPPLIED)	MAX. EFFORT ON HANDLE @ RATED LOAD
SELF ACTUATING	LIFTING	300KG (2940N)	1905KG	7.5m X 5mm	26KG

F18260

10:1 (500KG) BRAKE WINCH c/w CABLE



TYPE OF BRAKE	APPLICATION	RATED CAPACITY	CABLE BREAKING STRAIN	CABLE (AS SUPPLIED)	MAX. EFFORT ON HANDLE @ RATED LOAD
SELF ACTUATING	LIFTING	500KG (4900N)	2800KG	7.5m X 6mm	18KG



Part No.

Description

51D

4mm x 6mtr. Cable c/w Snap Hook

51E

5mm x 6mtr. Cable c/w Snap Hook

10111G

6mm x 5.5mtr. Cable c/w Snap Hook



Part No.

Description

51F

6mtr. Webbing c/w Snap Hook

10111H

7.5mtr. Webbing c/w Snap Hook