

COUPLING

AL-KO

• FIXED COUPLING

This style of coupling, usually suited to a 50mm Australian Standard towball, is suitable to be used where either there are no brakes fitted to the trailer or the braking system does not require activation from a sliding or overrun coupling.

AL-KO couplings are simple to attach to the towball and provide safe secure attachment of the trailer to the tow vehicle.

Typical applications for domestic trailers are up to 750 kg ATM (total loaded mass), where no brakes are required. For independent brake systems such as electric or power operated like the IQ7 system for marine trailers over 2000 kg ATM (total loaded mass), a fixed coupling is the appropriate selection. Fixed couplings for 50mm towballs are suitable for up to 3500 kg ATM (total loaded trailer mass) as long as the appropriate braking system is fitted to the trailer.

					
PART NUMBER	616200	614060	614075	614755	614010
DESCRIPTION	PRESS STEEL COUPLING	2 HOLE COUPLING	3 HOLE COUPLING	LEVER COUPLING	ELECTRIC COUPLING & LEVER
WEIGHT RATING	750kg	2000kg	2000kg	2000kg	3500kg
SUITS TOWBALL SIZE	50mm	50mm	50mm	50mm	50mm
MOUNTING HOLE (LXW) & DIAMETER	90mm x 12.2mm	101.6mm x 13.5mm	111.1mm x 51mm x 13.5mm	90mm x 36mm x 11mm	182.5mm x 55mm x 13.5mm
SURFACE FINISH	ZINC PLATED	PAINTED	ZINC PLATED	DACROMET	ZINC PLATED
BALL TO FIRST CENTRE HOLE (NOMINAL)	110mm	77mm	67mm	95mm	128mm

Helpful Hint: Use high tensile mounting bolts on all fixed couplings!

COUPLING

AL-KO

• OVER-RIDE COUPLING

On trailers between 750 kg and 2000 kg total laden mass, braking systems that use an override principal are acceptable, as long as they provide adequate braking for the trailer and tow vehicle combination.

The principal of this type of coupling is a sliding shaft attached to the tow ball housing of the coupling, and as the tow vehicle slows down the force of deceleration is passed through the coupling shaft and pushed either on a mechanical linkage (for mechanical brakes) or acts on a linkage connected to a hydraulic cylinder providing hydraulic pressure to a braking system (hydraulic brakes).

This type of coupling is efficient if the ball load is not excessive and when load levelling devices are not used, as these devices impede the smooth operation of the coupling, impeding the brake performance.



PART NUMBER	614040	614042	614050	614054
DESCRIPTION	HYDRAULIC OVER-RIDE COUPLING & 19mm MASTER CYLINDER	HYDRAULIC OVER-RIDE COUPLING & 22mm MASTER CYLINDER	MECHANICAL OVER-RIDE COUPLING & LEVER	MECHANICAL OVER-RIDE COUPLING ONLY
WEIGHT RATING	2000kg	2000kg	2000kg	2000kg
SUITS TOWBALL SIZE	50mm	50mm	50mm	50mm
MOUNTING HOLE (LXW) & DIAMETER	184mm x 54mm x 13.5mm	184mm x 54mm x 13.5mm	184mm x 54mm x 13.5mm	184mm x 54mm x 13.5mm
SURFACE FINISH	ZINC PLATED	ZINC PLATED	ZINC PLATED	ZINC PLATED
BALL TO FIRST CENTRE HOLE (NOMINAL)	137mm	137mm	137mm	137mm

COUPLING

AL-KO

• FIXED RING COUPLING

When used in a commercial or defence department application, often a 75 mm ring type towing eye is requested.

This style of coupling is similar in function to ball type couplings (fixed and over ride) but instead of the connection to the tow vehicle being a standard 50 mm ball, the connection is a 75 mm inside diameter ring and this attaches to a "pintle hook" fitted to the tow vehicle. These types of couplings are primarily used in applications where the tow vehicle is a heavy commercial truck. As the Australian Standard AS4177 states the 50mm towball to have a maximum capacity of 3500 kg ATM (total loaded mass), ring couplings are used when higher loads are involved.



PART NUMBER	614304	614309
DESCRIPTION	3" RING FIXED COUPLING (3 HOLE)	3" RING FIXED COUPLING (4 HOLE)
WEIGHT RATING	3500kg	6000kg
RING SIZE	75mm	75mm
MOUNTING HOLE (LXW) & DIAMETER	103mm x 56mm x 16.8mm	182mm x 52mm x 16.8mm
SURFACE FINISH	ZINC PLATED	ZINC PLATED
BALL TO FIRST CENTRE HOLE (NOMINAL)	86mm	116mm

COUPLING



AL-KO

• OFF-ROAD COUPLING

When a coupling is used for rough off-road use the Australian Standard degree of articulation (or angles of available movement) may be insufficient. AL-KO has solved this problem with the AL-KO Off Road Coupling. When off-road 4WD vehicles tow trailers in rugged outback conditions it is advisable that a coupling specifically designed to have greater angular movement is used.

The AL-KO Off Road Coupling with 360 degree articulation and positive towball latching system offer the maximum degree of articulation as well as a design that has been tested to 2 million fatigue test cycles, so you know that it will pass all tests.

AL-KO has a range of suitable "off-road" couplings in both fixed and override functions to provide the appropriate articulation for this use.

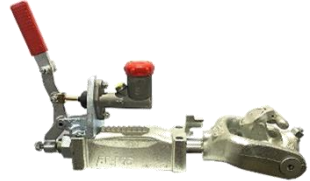
				
PART NUMBER	619350	619200	619200/53	619200/43
DESCRIPTION	ELECTRIC SWIVEL OFF-ROAD COUPLING (NON-OVER-RIDE) (NEW STYLE)	OVER-RIDE OFF-ROAD COUPLING ONLY (NEW STYLE)	MECHANICAL OVER-RIDE OFF-ROAD COUPLING & LEVER (NEW STYLE)	HYDRAULIC OVER-RIDE OFF-ROAD COUPLING & 19mm MASTER CYLINDER (NEW STYLE)
WEIGHT RATING	3500kg	2000kg	2000kg	2000kg
SUITS TOWBALL SIZE	50mm	50mm	50mm	50mm
MOUNTING HOLE (LXW)	184mm x 54mm	184mm x 54mm	184mm x 54mm	184mm x 54mm
SURFACE FINISH	ZINC PLATED	ZINC PLATED	ZINC PLATED	ZINC PLATED

COUPLING

AL-KO

• OFF-ROAD PIN COUPLING

Innovative market leader AL-KO has taken ease of use to a new level with the release of the AL-KO Off-Road Pin Coupling featuring their new patent pending Click Lock™ system.



With the development of Click Lock, AL-KO now offers an off-road pin coupling that is self-locking – automatically completing the primary and secondary locking required for ADR compliance, with no additional action required by the user. The result is hands free hitching, making it safer and easier to use than other pin couplings on the market. To hitch up, simply lower the coupling over the pin. An integrated positive latching indicator confirms that you are ready to go when it clicks into place.

AL-KO's unique forged yoke allows maximum articulation on both horizontal and vertical planes sustained up to 3500kg ATM. A built in cover makes the coupling completely sealed from the elements with no loose parts, levers or dust caps. The product has the lowest profile of any pin coupling on the market at just 83mm, making it ideal for tow vehicles with barn doors.

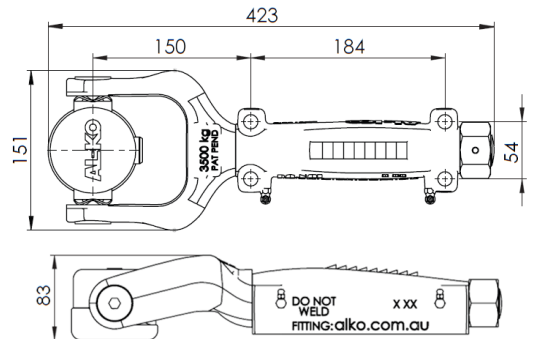
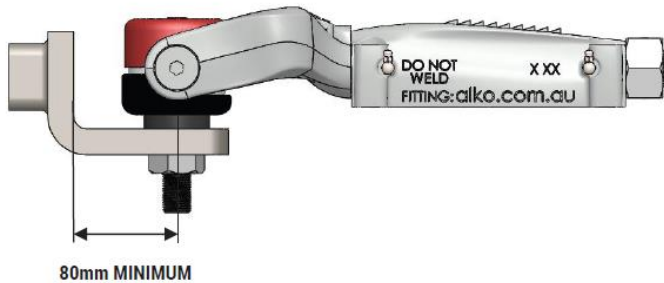
	PART NUMBER	DESCRIPTION	WEIGHT RATING	MOUNTING HOLE (LXW) & DIAMETER	SURFACE FINISH	PIN TO FIRST CENTRE HOLE (NOMINAL)
	619400	OFF-ROAD PIN COUPLING c/w PIN	3500 kg	184 x 54mm	ZINC PLATED	150 mm

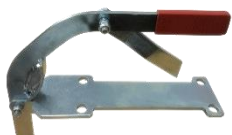

SPARE PARTS to suit ABOVE COUPLING:

	PART NUMBER	DESCRIPTION
	619410	PIN to suit OFF-ROAD PIN COUPLING
	619411	COVER to suit PIN
	614055	BASE PLATE & LEVER suit AK PIN COUPLING ONLY (184 x 54 x 13.5mm)

COUPLING

AL-KO

• SWAY CONTROL COUPLING

AL-KO has a specific coupling designed to reduce trailer sway. This 50mm ball type fixed coupling is designed to be used on trailer up to 2500 kg ATM (total loaded mass) and with a maximum towball weight of 250 kg.



This unique product incorporates a clamping system that grips the sides of a specially designed 50 mm tow ball and resists movement of the trailer. This action slows down any tendency for the trailer to sway or veer from a straight condition.

This is particularly a benefit when large trailers such as caravans are buffeted by side winds or by a passing truck and trailer combination.

****NOTE: This type of coupling must only be used with a 50mm ball which has an anti-rotation plate for attachment to the vehicle fitted.****

	PART NUMBER	DESCRIPTION	WEIGHT RATING	SUITS TOWBALL SIZE	MOUNTING HOLE (LXW) & DIAMETER	SURFACE FINISH	BALL TO FIRST CENTRE HOLE (NOMINAL)
	618000	AKS 3000 STABILIZER COUPLING	2500kg	50mm	184mm x 54mm x 13.5mm	ZINC PLATED	203mm

SPARE PARTS to suit ABOVE COUPLING:

	PART NUMBER	DESCRIPTION	SUITS TOWBALL SIZE	SIZE
	618100	RETENSION PLATE to suit AKS 2000 & 3000	50mm	75mm WIDE
	618901	AKS 3000 HIGH RISE TOWBALL	50mm	—
	618904	AKS 3000 STANDARD TOWBALL	50mm	—

COUPLING

AL-KO

	PART NUMBER	DESCRIPTION	SURFACE FINISH	MOUNTING HOLE (LXW) & DIAMETER
	P6575	19mm or 3/4" MASTER CYLINDER ONLY	--	--
	P7890	22mm or 7/8" MASTER CYLINDER ONLY	--	--
	619043	MASTER CYLINDER MOUNT BRACKET c/w 19mm MASTER CYLINDER	ZINC PLATED	--
	610944	MASTER CYLINDER MOUNT BRACKET c/w 22mm MASTER CYLINDER	ZINC PLATED	--
	614053	MECHANICAL BASE PLATE & LEVER	ZINC PLATED	184mm x 54mm x 13.5mm
	619100	AK ZINC PLATED HANDBRAKE LEVER	ZINC PLATED	--